

2 0 2 4 - 2 0 2 5



sustainable innovation for your networks



**GAS
CABINETS**



**NETWORK
PROTECTION**



**CATHODIC
PROTECTION**



**ATEX
TOOLS**



SIGNAGE

www.pch-sas.com

EXPERTISE AND CUSTOMIZED SERVICES

PCh is a manufacturer of equipment for gas and water networks.

We are a subsidiary of the Michaud Group, a recognized player in the field of low-voltage electrical distribution for over 50 years.

This catalog offers you a range of products for gas networks with ever more demanding commitments.



INNOVATION

Designing today your products of tomorrow.



REACTIVITY

Offering services tailored to your needs.



THE QUALITY

Prioritizing customer satisfaction.



SUSTAINABLE DEVELOPMENT

Cultivating our social and environmental approach.



PCh, a responsible and environmental approach

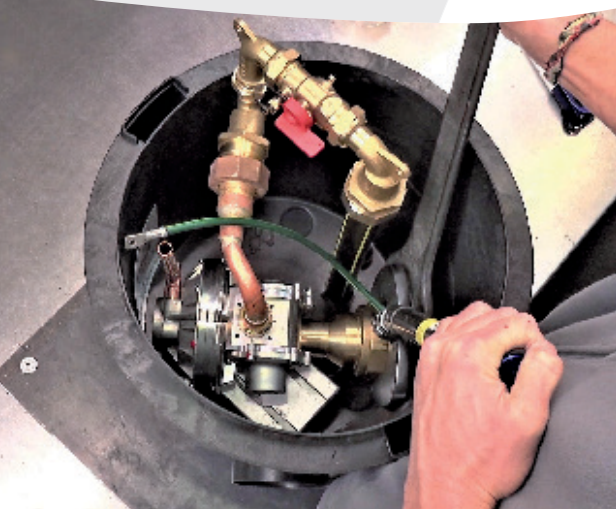



I • METER BOXES, GAS CABINETS, METAL BOXES AND ENCLOSURES

- GAS CABINETS
 - Buried cabinet 6
 - Buried pipe ventilation cabinet for directional drilling 10
 - Manhole cover 12
 - S2400 cabinet 14
 - Shut-off cabinet for single units 16
 - S2400/ S2300 panel renovation kit 18
 - S22 cabinet 20
 - S300 cabinet 22
 - Horizontal renovation cabinet 24
 - Horizontal renovation adaptation kit for smart meter 26
 - Miscellaneous cabinets and accessories 28
 - Adaptor kit for cabinet supports 29
 - Extension kit for cabinet supports 30
- TECHNICAL ENCLOSURES
 - Outdoor gas technical enclosure 32
 - Kitchen supply technical enclosure 34
- GAS STATIONS
 - Underground network stations with double tapping 36
 - Low pressure metering only customer stations 38
 - Network station MLP/LP Type R or Type D 40



II • NETWORK PROTECTION

- MECHANICAL PROTECTION
 - Meter board for building network 46
 - Tubing system 48
 - HDPE gas network cover plates 50
 - Protective riser sleeves and gas bends 52
 - All-in-one universal sleeve and bend 53
 - PE sealing caps 54
 - Aluminium tube protection cover 56
 - Pipe casing spacers 57
 - Equipment for securing branch valves 58



III • ANTI-CORROSION PROTECTION

- PASSIVE PROTECTION
 - Petrolatum tapes 62
 - Rigid mold resin coating kit 64
 - Soft molds resin coating kit 66
- CATHODIC PROTECTION
 - Brazing pins 68
 - Aluminothermy kit 69
 - Gel connection boxes 70
 - Resin connection boxes 71
 - Measurement device 72
 - Anodes - Heat-shrinkable sleeves 73



IV • TOOLS AND ACCESSORIES

- NETWORK PROTECTION
 - ATEX Tools 76
 - ATEX Signage 77
 - ATEX Lighting 78
- MECHANICAL PROTECTIONS
 - Bolt and gasket kits for flanges 80
 - Jointing paste for threaded metal assembly 82
 - Sealing products 83
- NETWORK ACCESSORIES
 - Temperature indicators 84
 - G4/G6 Meter accessories 86



V • SIGNAGE











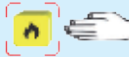

- Signage 90
- Signage cases 91

TECHNICAL BASELINE

IP RATING

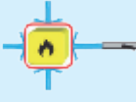
- Defined by the international standard EN 60529.

It consists of 2 digits, the first digit indicates protection against solid objects, the second indicates protection against liquids such as water.

1 st number		2 nd number	
0	No protection.	0	No protection.
1	 Protected against solid objects with a diameter greater than 50 mm (back of hand).	1	 Protected against vertically falling drops of water (condensation).
2	 Protected against solid objects with a diameter greater than 12 mm (finger).	2	 Protected against drops of water up to 15° of inclination.
3	 Protected against solid object with a diameter greater than 2.5 mm (wires, tools).	3	 Protected against rainwater up to 60° of inclination.
4	 Protected against solid object with a diameter greater than 1 mm.	4	 Protected against water projections from all directions.
5	 Protected against dust (no harmful deposit).	5	 Protected against water jets from all directions.
6	 Dust proof.	6	 Protected against powerful water jets.
		7	 Protected against the effects of immersion.
		8	 Protected against prolonged effects of immersion under pressure.

IK PROTECTION AGAINST MECHANICAL IMPACTS

- Defined by the international standard EN 62262 and consists of 2 digits ranging from 00 to 10.

	00	01	02	03	04	05	06	07	08	09	10
ENERGY IMPACT (in joules)	NOT PROTECTED	0.15	0.2	0.35	0.5	0.7	1	2	5	10	20
EQUIVALENT IMPACT (weight at 10 cm)	NOT PROTECTED	150 G	200 G	350 G	500 G	700 G	1 KG	2 KG	5 KG	10 KG	20 KG

PRODUCT COMPLIANCE

QUALIFICATION TESTS

- Our engineering teams work every day to offer to you the most innovative solutions.
- Our products are qualified according to applicable standards through external laboratories to guarantee their compliance.



RECURRENT TESTS

- Throughout the product's life, recurrent tests are carried out in the factory by our quality teams.
- They perform statistical sampling in the components, work-in-progress, and finished products stocks, with the aim of ensuring flawless quality.
- The equipped cabinets are individually validated by passing them through the sealing test bench according to GRDF standards.

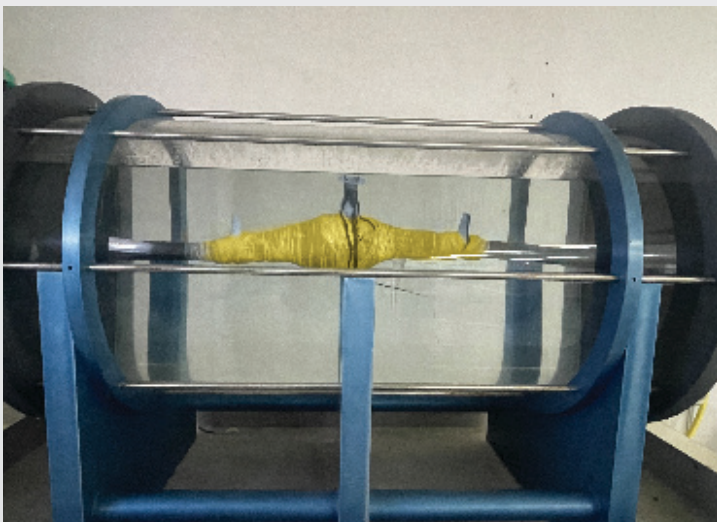
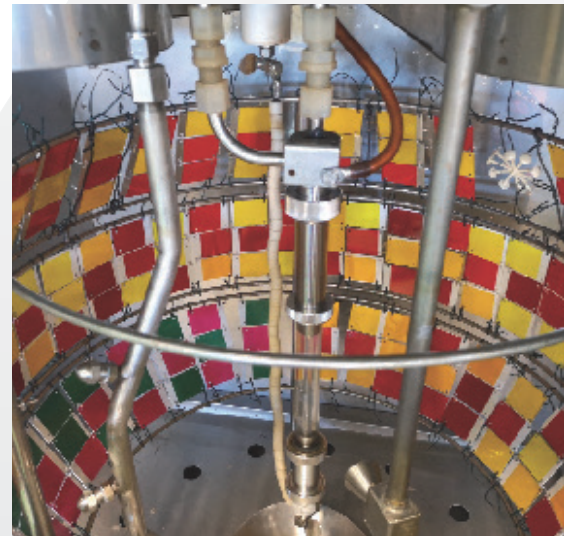





METER BOXES, GAS CABINETS, METAL BOXES AND ENCLOSURES

● GAS CABINETS

Buried cabinet	6
Buried pipe ventilation cabinet for directional drilling	10
Manhole cover	12
S2400 cabinet	14
Shut-off cabinet for single units	16
S2400/S2300 panel renovation kit	18
S22 cabinet	20
S300 cabinet	22
Horizontal renovation cabinet	24
Horizontal renovation adaptation kit for smart meter	26
Miscellaneous cabinets and accessories	28
Adaptor kit for cabinet supports	29
Extension kit for cabinet supports	30

● TECHNICAL ENCLOSURES

Outdoor gas technical enclosure	32
Kitchen supply technical enclosure	34

● GAS STATIONS

Underground network stations with double tapping	36
LP metering only customer stations	38
Network station MLP/LP, type R or type D	40



Video of our
cabinets fabrication

GAS CABINET



BURIED CABINET

USAGE

- Installation on medium-pressure network (up to 4 bar) or low-pressure network (up to 50 mbar).
- Realization of shut-off and expansion connection.
- Installation under the sidewalk with the provided cast iron manhole cover of C250 class (250KN).
- Possible installation on the roadway with a D400 class (400KN) (not provided see Page 12-13).
- Ensures a flow rate of 6 to 65 m³/h depending on the versions.
- Also available in a low-pressure version transformable to medium-pressure.
- Flow rate up to 100 m³/h.

ADVANTAGES

- Sliding composite frame adjustable at the road level.
- Removable and repositionable sealing system for inputs and outputs.
- Lid = multiple ventilation opening, waterproof against runoff water.

ADVANTAGES OF VERTICAL OUTPUT

- Bend vertical output ensuring compliance with the minimum load requirement: depth of copper output > 50 cm.
- Facilitated alignment of the input and output, allowing compliance with class A connection.
- Gas pipe input with a margin of manoeuvre, facilitating installation and avoiding tension during compaction.



DESCRIPTION

MATERIALS USED:

- Vat and cover: thermoplastic material.
- Manhole: cast iron with a capacity of 250 KN.
- Manhole frame: synthetic materials according to EN 124-5 standard.
- Sealing system for inputs/outputs: flexible thermoplastic.
- PVC supports with a diameter of 40 mm.

PROTECTION RATING:

- IPX1 according to EN 60529.
- IK09 according to EN 62262.

RANGE	PIPE ENTRY mm	PIPE EXIT mm	VAT
B6 & BCH30	PE Ø 20	Ø 28 COPPER	SIMPLE
B10 & B25	PE Ø 20	Ø 35 COPPER	SIMPLE
C40, C65, C100 CCH50 & CCH80	PE Ø 32	Ø 54 COPPER	DOUBLE

LP/MP C25	PE Ø 32	Ø 28 COPPER	SIMPLE
LP/MP	PE Ø 40	Ø 35 COPPER	SIMPLE

SIMPLE CUT	PE Ø 20	PE Ø 20	SIMPLE
-------------------	---------	---------	--------

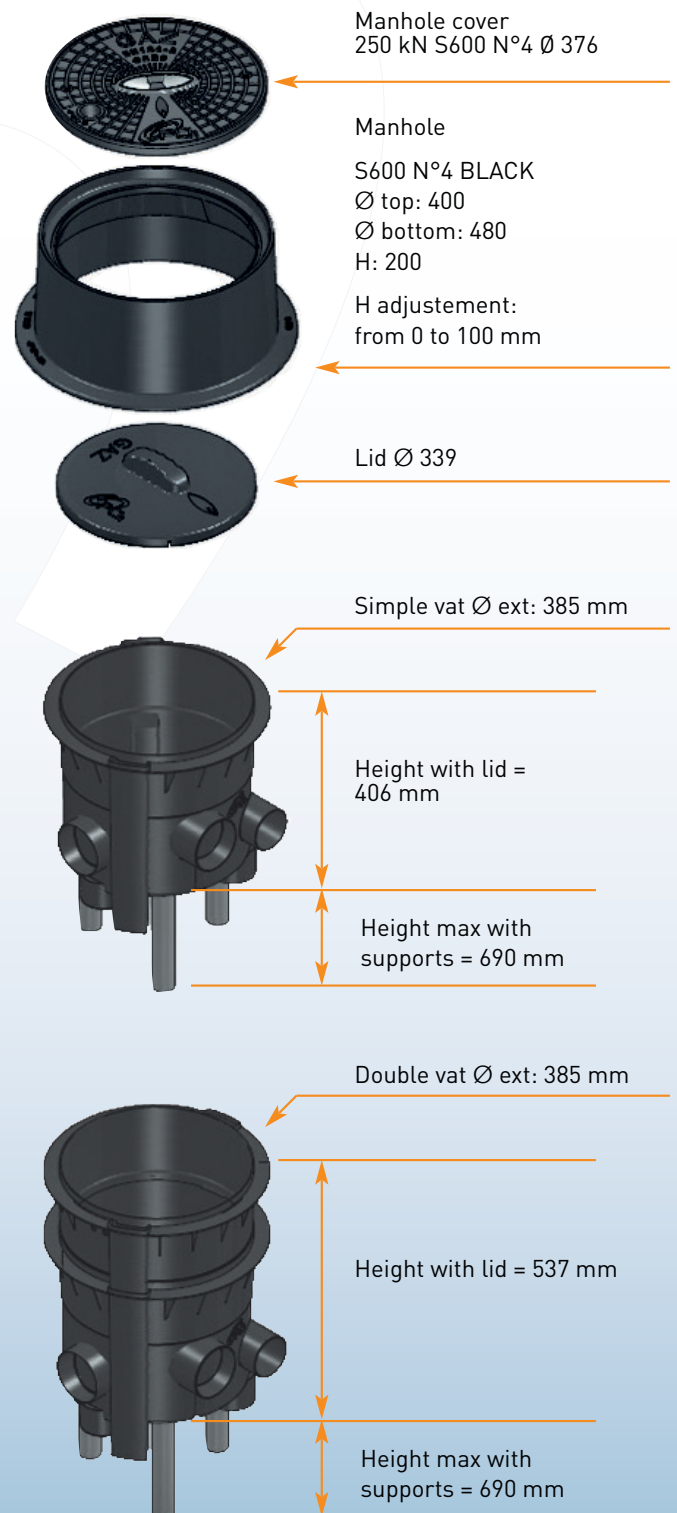

GAS CABINET

BURIED CABINET, HORIZONTAL EXIT



SHUT-OFF AND REGULATOR REFERENCES

CODE	DESIGNATION	GRDF REFERENCE
XA400	BURIED CABINET B6NE 21MB WITH MANHOLE	85 00 476
XA401	BURIED CABINET B6NE 27MB WITH MANHOLE	85 00 478
XA402	BURIED CABINET B10NE 21MB WITH MANHOLE	85 00 485
XA403	BURIED CABINET B10NE 27MB WITH MANHOLE	85 00 487
XA404	BURIED CABINET B25NE 21MB WITH MANHOLE	85 00 493
XA405	BURIED CABINET B25NE 27MB WITH MANHOLE	85 00 495
XA408	BURIED CABINET C40E CU50 A REG VALVE EA WITH MANHOLE	85 00 529
XA409	BURIED CABINET C65E CU50 A REG VALVE EA WITH MANHOLE	85 00 536

SHUT-OFF LOW PRESSURE UPGRADEABLE TO MEDIUM PRESSURE CHANGEABLE

CODE	DESIGNATION	GRDF REFERENCE
XA406	BURIED CABINET LP/MP C25 VALVE E1A WITH MANHOLE	85 00 506
XA407	BURIED CABINET LP/MP WITH MANHOLE	85 00 507

BURIED CABINET, VERTICAL ENTRY-EXIT

Video
www.pch-sas.com

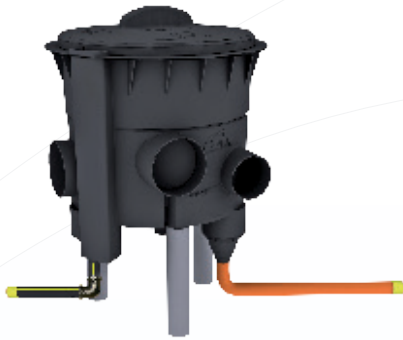

Range B6 à B25 & BCH 30NE

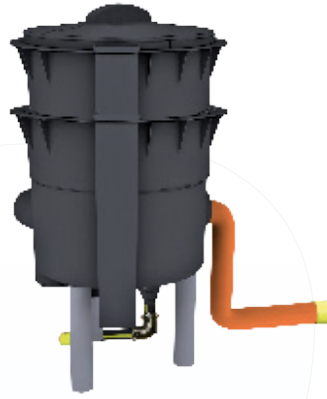

Range C40 à C65, C100, CCH50E & CCH80E



Single shut-off range

SHUT-OFF AND REGULATOR REFERENCES

CODE	DESIGNATION	GRDF REFERENCE
XA420	BURIED CABINET VERTICAL ENTRY-EXIT B6NE 21MB WITH MANHOLE	85 00 500
XA421	BURIED CABINET VERTICAL ENTRY-EXIT B6NE 27MB WITH MANHOLE	85 00 502
XA422	BURIED CABINET VERTICAL ENTRY-EXIT B10NE 21MB WITH MANHOLE	85 00 503
XA423	BURIED CABINET VERTICAL ENTRY-EXIT B10NE 27MB WITH MANHOLE	85 00 504
XA424	BURIED CABINET VERTICAL ENTRY-EXIT B25NE 21MB WITH MANHOLE	85 00 508
XA425	BURIED CABINET VERTICAL ENTRY-EXIT B25NE 27MB WITH MANHOLE	85 00 509
XA426	BURIED CABINET VERTICAL ENTRY-EXIT C40E 21MB WITH MANHOLE	85 00 514
XA451	BURIED CABINET VERTICAL ENTRY-EXIT C40E 27MB WITH MANHOLE	85 00 551
XA427	BURIED CABINET VERTICAL ENTRY-EXIT C65E 21MB WITH MANHOLE	85 00 521
XA452	BURIED CABINET VERTICAL ENTRY-EXIT C65E 27MB WITH MANHOLE	85 00 553
XA439	BURIED CABINET VERTICAL ENTRY-EXIT C100E 21MB WITH MANHOLE	85 00 541
XA450	BURIED CABINET VERTICAL ENTRY-EXIT C100E 27MB WITH MANHOLE	85 00 555
XA430	BURIED CABINET VERTICAL ENTRY-EXIT BCH30NE WITH MANHOLE	85 00 534
XA431	BURIED CABINET VERTICAL ENTRY-EXIT CCH50E WITH MANHOLE	85 00 548
XA432	BURIED CABINET VERTICAL ENTRY-EXIT CCH80E WITH MANHOLE	85 00 549

SHUT-OFF REFERENCES

CODE	DESIGNATION	GRDF REFERENCE
XA428	BURIED CABINET WITH VERTICAL ENTRY-EXIT, EQUIPPED WITH SINGLE SHUT-OFF TYPE E DN15 WITH MANHOLE	85 00 526
XA429	BURIED CABINET VERTICAL ENTRY-EXIT, EQUIPPED WITH SINGLE SHUT-OFF TYPE E DN25 WITH MANHOLE	85 00 527

GAS CABINET



BURIED PIPE VENTILATION CABINET FOR DIRECTIONAL DRILLING USAGE

USAGE

- Ventilation of the directional drilling sleeve used to protect the gas pipeline (road or river crossing).
- Accessibility for periodic verification.

ADVANTAGES

- Buried vat and internal components approved by GRDF.
- Integrated connection allowing the installation of a flare stack.
- Easy access for the inspections.
- Delivered with composite frame and cast-iron manhole cover.
- Cover that adapts to drillings sleeves with a diameter of 125 to 315 mm.

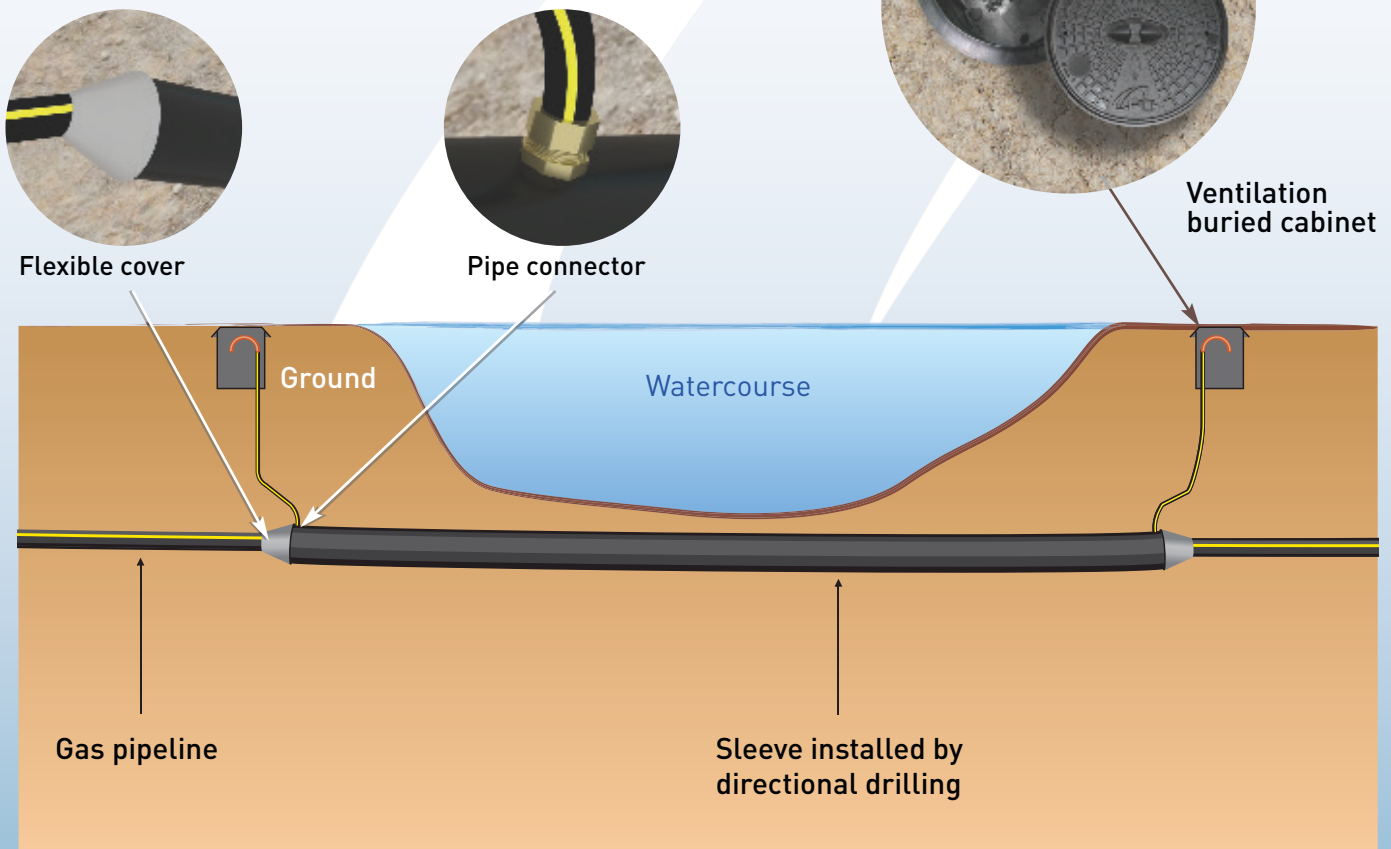

DESCRIPTION

COMPOSITION:

- Vat and cover: thermoplastic material.
- Manhole: cast iron with a capacity of 250 kn.
- Manhole cover: synthetic materials according to the EN 124-5 standard.
- Sealing system for gas pipe input: Flexible thermoplastic.
- PVC supports Ø 40 mm.
- Kit XA435: two mechanical gas pipe fittings and one drill.
- Kit XA436: two sealing covers with clamps and tape.
- Kit XA437: two XA434 cabinets, one XA435 kit and one XA436 kit.

DEGREES OF PROTECTION:

- IPX1 according to EN 60529.
- IK09 according to EN 62262.



REFERENCES

CODE	DESIGNATION	GRDF REFERENCE
XA434	BURIED VENTILATION CABINET	85 05 011
XA435	* PE Ø 32 PIPE CONNECTOR	
XA436	* SLEEVE COVER KIT	
XA437	FULL KIT FOR 2 CABINETS	85 05 012

* Product in stock, available on quotation.

MANHOLE COVER

USAGE

- The manhole covers allow the access for handling, connection or maintenance of buried equipment.
- The manhole covers are composed of a frame and a removable cover.
- They are positioned on sidewalks (C250) or roadways (D400).

ADVANTAGES

- In compliance with EN 124 standard.
- The references XA484 and XA483 are hybrid.
- Frame made of synthetic materials and cover made of cast iron.
- Compared to one made only in cast iron, this allows:
 - 65% in reduction in the weight of the frame.
 - Reduction of accidents associated with handling.
 - Better carbon footprint (gain of 30 kg of CO₂ over the entire product lifecycle).
- Integrated locking system.



XA483

DESCRIPTION

MATERIALS USED:

- Cast iron (cover and frame of the N°2 and N°3).
- Synthetic materials according to the EN 124-5 standard (cover of the N°4 and oval).

RESISTANCE:

- C250: 250kN load tested.
- D400: 400kN load tested.
- Manhole in compliance with EN 124 standard.



XA484

REFERENCES

CODE	DESIGNATION	GRDF REFERENCE
XA480	CAST IRON OVAL GAS MANHOLE COVER D400	85 10 050
XA481	CAST IRON ROUND GAS MANHOLE COVER N°2 D400	85 10 150
XA482	CAST IRON ROUND GAS MANHOLE COVER N°3 D400	85 10 151
XA483	ROUND GAS MANHOLE COVER C250	85 11 180
XA484	HYBRID OVAL GAS MANHOLE COVER D400	85 10 051

GAS CABINET

S2400 CABINET

USAGE

- Range of enclosures for making connections for shut-off, regulation/ metering of 6 m³/h and for shut-off/ regulation of 6 to 65 m³/h.
- Modular range: the cabinet can be transformed into a higher cabinet by adding a high or low base.
- The flow can go up to 100 m³/h.

ADVANTAGES

- Compatible with electronic or smart gas meters.
- Modern and consistent design with new low-voltage network and public lighting emergencies
- The connection can be made for both low-pressure and medium-pressure networks.

DESCRIPTION

MATERIAL OF THE CABINET:

- Molded cabinet made of polyester reinforced with fiberglass.

CABINET COLOR:

- Ivory RAL 1015.

MOUNTING:

- Flush-mounted or surface-mounted, mountable on a base.

WIDTH*HEIGHT*DEPTH (MM):

- 350 x 485 x 195.

LOCK:

- Locking device operated by rectangular key.

PROTECTION RATING:

- IP33 according to EN 60529.
- IK10 according to EN 62262.



XA001

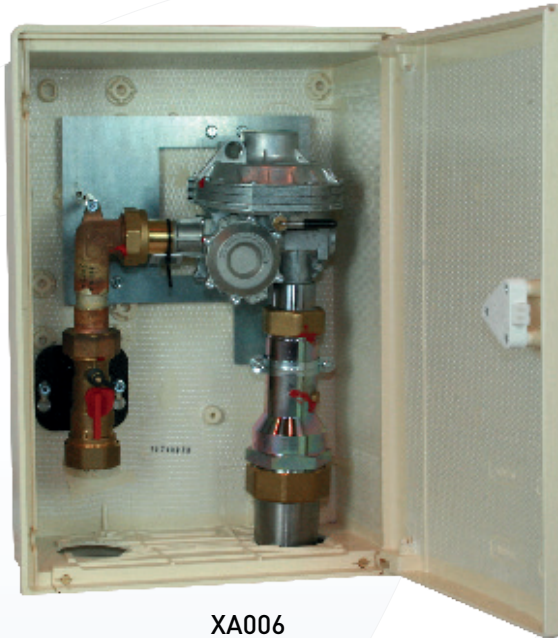

XA005

XA006

REFERENCES

CODE	DESIGNATION	GRDF REFERENCE
XA001	S2400 CABINET B6 21MB	85 04 025
XA006	S2400 CABINET C40 21MB VALVE E1A	85 04 020
XA007	S2400 CABINET C40 27MB VALVE E1A	85 04 021
XA008	S2400 CABINET C65 21MB VALVE E1A	85 04 022
XA009	S2400 CABINET C65 27MB VALVE E1A	85 04 023
XA010	S2400 CABINET C100 21MB VALVE E1A-AC60	85 04 026
XA011	S2400 CABINET C100 27MB VALVE E1A-AC60	85 04 027
XA042	S2400 CABINET PANEL MP 37MB VALVE E1	85 04 047
XA043	S2400 CABINET PANEL LP VALVE E1	85 04 048
XA017	S2400 BASE HIGH	85 00 658
XA018	S2400 LOW BASE	85 04 002
XA013	S2400 EMPTY CABINET RECTANGLE LOCK	85 04 036
XA037	S2400 EMPTY CABINET TRIANGLE LOCK	85 04 037
XA036	S2400 EMPTY CABINET DOOR	85 04 000
XA014	S2400 DOOR IVORY RECTANGLE LOCK	85 04 001

GAS CABINET



SHUT-OFF CABINET FOR SINGLE UNITS

USAGE

- The French decree of February 23, 2018 defines a single unit as an buildings complex consisting of individual and/or collective housing units whose indoor gas installations are supplied by a common gas distribution network.
- These new units must be equipped with a main valve (general shut-off device) at the property boundary and a secondary valve (complementary shut-off device) before the entrance of each building.

ADVANTAGES

- Equipped with the new hingeless panel reduced maintenance and ease of access to the inside of the cabinet.
- Mounting possible on high base, low base or flush-mounted.
- Shut-off visible on cabinet with general shut-off device by simply removing the input/output copper connection and placing caps on the outlets.

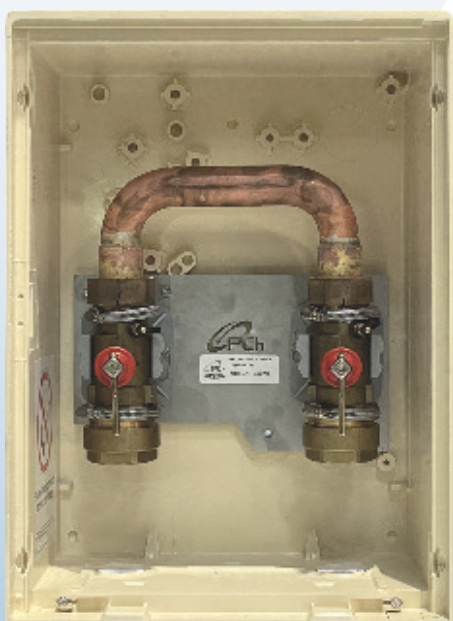

XA020



XA022



DESCRIPTION

MATERIAL OF THE CABINET:

- Molded cabinet made of polyester reinforced with fiberglass.

COLOR:

- Ivory RAL 1015.

MOUNTING:

- Flush-mounted or surface-mounted, mountable on a base.

WIDTH*HEIGHT*DEPTH (MM):

- 50 x 485 x 195.

LOCK:

- Locking device operated with a triangular key.

PROTECTION RATING:

- IK10 according to EN 62262.
- IP43 according to EN 60529.



XA023

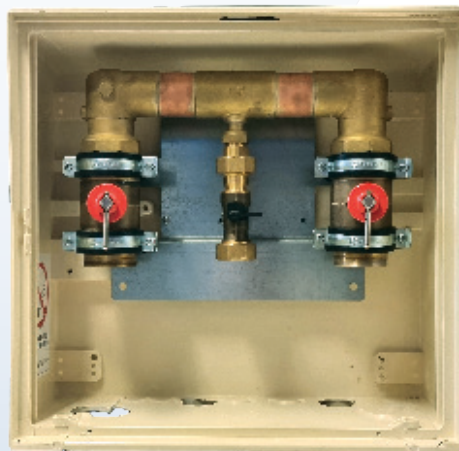

XA216

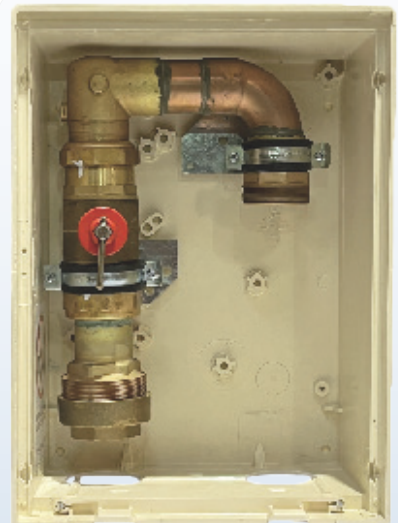

XA024

REFERENCES

CODE	DESIGNATION	GRDF REFERENCE
XA020	S2400 O.C.G. MLP VALVE E1A PE40/32 SC CABINET	85 04 033
XA024	S2400 SHUT-OFF CABINET LP VALVE CA SECU PE63/50 PG	85 04 042
XA022	S2400 SHUT-OFF CABINET MLP VALVE E1A PE32/25 SC	85 04 040
XA023	S2400 SHUT-OFF CABINET MLP VALVE E1A PE40/32 SC	85 04 041
XA216	S300 O.C.G. VALVE EA 50 CABINET	85 04 009
XA041	S2400 CABINET LP AND MLP PE 63 PANEL	85 04 043

GAS CABINET



S2400/S2300 PANEL RENOVATION KIT

 Video
www.pch-sas.com



USAGE

- Repair or replacement of S2400/S2300 enclosure doors with a hingless removable panel.

ADVANTAGES

- Compatible with all generations and brands of S2300 and S2400 cabinets or high cabinets.
- Simplified access to the inside of the cabinet.
- Increased interior space to facilitate the installation of smart meters.
- More robust solution than hinged doors.
- Easy to implement using a simple flathead screwdriver.
- Reversible lock with 1/4 turn captive screws (adaptation to different brands).
- Durable maintenance.

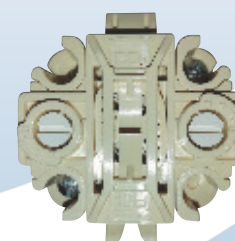

Reversible lock



DESCRIPTION

COMPOSITION:

- Adapter strip + fixing screws.
- Reversible double bolt lock.
- Panel made of polyester reinforced with fiberglass.

COLOR:

- Ivory RAL 1015.

MOUNTING:

- Flush-mounted or surface-mounted, mountable on a base.

LOCK:

- Locking device operated by rectangular key.

PROTECTION RATING:

- IP33 according to EN 60529.
- IK10 according to EN 62262.

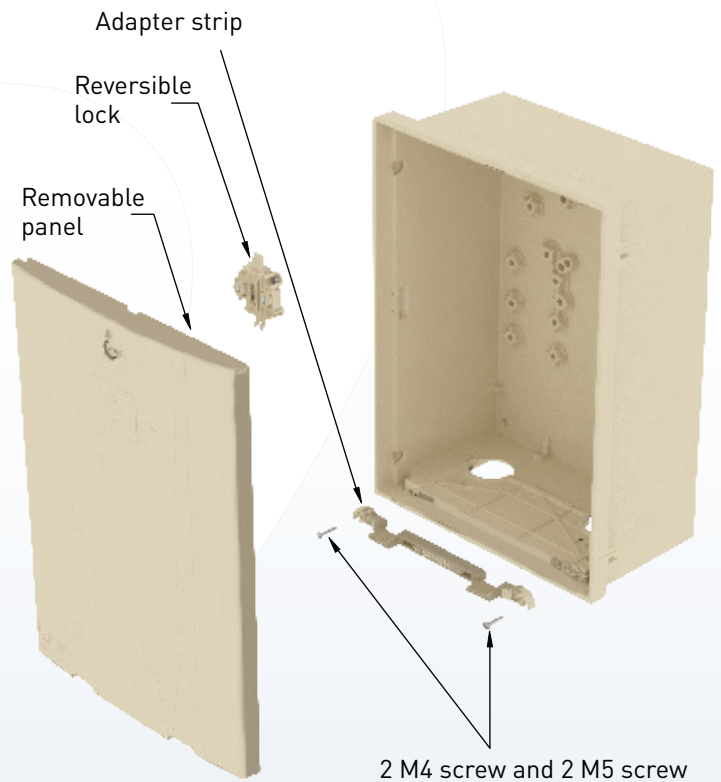

REFERENCE

CODE	DESIGNATION	GRDF REFERENCE
XA015	S2400/S2300 PANEL RENOVATION KIT RECTANGLE LOCK	85 04 003
XA040	S2400/S2300 PANEL RENOVATION TRIANGLE LOCK	85 04 034
XA016	S2400 PANEL RECTANGLE LOCK	85 04 004
XA035	S2400 PANEL TRIANGLE LOCK	85 04 035

GAS CABINET

S22 CABINET

USAGE

- Allows the realization of connections/shut-off/regulation from 6 to 30 m³/h.

ADVANTAGES

Cabinet available in three possible configurations:

- Low cabinet.
- Tall cabinet.
- High cabinet.

DESCRIPTION

CABINET MATERIAL:

- Molded cabinet made of polyester reinforced with fiber-glass.

CABINET COLOR:

- Ivory RAL 1015.

FIXING:

- Flush-mounted or surfacemounted, mountable on a base.

WIDTH*HEIGHT*DEPTH (MM):

- Low cabinet: 230 x 340 x 180.
- Tall cabinet: 230 x 485 x 180.
- High cabinet: 230 x 692 x 180.

LOCK:

- Locking device operated by rectangular key.

PROTECTION RATING:

- IP43 according to EN 60529.



XA100



XA107



XA117

REFERENCES

CODE	DESIGNATION	GRDF REFERENCE
XA100	S22 B6N 21MB VALVE E1 LOW CABINET	85 00 918
XA113	S22 B6N 27MB VALVE E1A LOW CABINET	85 02 001
XA102	S22 B10N 21MB VALVE E1A LOW CABINET	85 00 928
XA114	S22 B10 27MB VALVE E1A LOW CABINET	85 02 002
XA101	S22 B25N 21MB VALVE E1A LOW CABINET	85 00 921
XA115	S22 B25N 27MB VALVE E1A LOW CABINET	85 02 003
XA103	S22 B6N 21MB VALVE E1A TALL CABINET	85 00 930
XA106	S22 B6N 21MB VALVE E1A TALL CABINET	85 00 942
XA104	S22 B25N 21MB VALVE E1A TALL CABINET	85 00 933
XA105	S22 LP/MP VALVE E1A TALL CABINET	85 00 939
XA107	S22 LP/MP VALVE E1A 25/32 TALL CABINET	85 00 944
XA108	S22 B6N 21MB VALVE E1 HIGH CABINET	85 00 945
XA111	S22 B10N 21MB VALVE E1A HIGH CABINET	85 00 957
XA116	S22 B10N 27MB VALVE E1A HIGH CABINET	85 02 021
XA109	S22 B25N 21MB VALVE E1A HIGH CABINET	85 00 948
XA117	S22 B25N 27MB VALVE E1A HIGH CABINET	85 02 022
XA110	S22 LP/MP VALVE E1 HIGH CABINET	85 00 954
XA112	S22 LP/MP VALVE E1A 25/32 HIGH CABINET	85 00 959
XA118	EMPTY LOW CABINET S22 FLAME	85 00 910
XA119	LOW CABINET DOOR S22 FLAME	85 00 911
XA120	EMPTY TALL CABINET S22 FLAME	85 00 912
XA122	TALL CABINET DOOR S22 FLAME	85 00 914
XA121	EMPTY HIGH CABINET S22 FLAME	85 00 913
XA123	EMPTY BASE S22 FLAME	85 00 915

GAS CABINET

S300 CABINET

USAGE

- Allows for double shut-off/regulation/metering connections, up to 6 m³/h or single up to 30 m³/h.

DESCRIPTION

CABINET MATERIAL:

- Cabinet in molded polyester reinforced with fiberglass or PVC depending on the references

CABINET COLOR:

- Ivory RAL 1015.

WIDTH*HEIGHT*DEPTH (MM):

- 532 x 520 x 202.

LOCK:

- Locking device operated by rectangular key.

PROTECTION RATING:

- IP43 according to EN 60529.
- IK10 according to EN 62262.

IMPLEMENTATION:

- Can be recessed or placed on a base according to the MCOF303 standard.
- The implementation specifications are defined in the BRCM91 standard.



XA221



XA225

REFERENCES

CODE	DESIGNATION	GRDF REFERENCE
XA220	S300 2 SMART METER LP G4 CABINET	84 53 751
XA221	S300 SMART METER MP 2G4 B6N 21MB CABINET	84 53 752
XA222	S300 SMART METER MP 2G4 B6N 27MB CABINET	84 53 753
XA223	S300 SMART METER MP B10N 21MB E1A CABINET	84 53 754
XA224	S300 SMART METER MP B10N 27MB E1A CABINET	84 53 755
XA225	S300 SMART METER MP B25N 21MB E1A CABINET	84 53 756
XA226	S300 SMART METER MP B25N 27MB E1A CABINET	84 53 757
XA227	S300 SMART METER LP G6/10 E1A CABINET	84 53 758
XA228	S300 SMART METER BCH30N 300MB E1A CABINET	84 53 759
XA209	S300 IVORY BASE	84 53 750
XA210	S300 IVORY EMPTY CABINET	85 00 301
XA511	S300 IVORY EMPTY CABINET FOR SMART METER	85 00 305
XA513	S300 IVORY DOOR FOR SMART METER	85 00 381
XA212	S300 SPECIAL GREY DOOR	85 00 392
XA213	S300 IVORY DOOR WITH WINDOW	85 00 393
XA215	S300 SPECIAL IVORY DOOR	85 00 395
XA512	S300 GREY DOOR FOR SMART METER	85 00 382

GAS CABINET



HORIZONTAL RENOVATION CABINET

USAGE

- Low-height equipped cabinet for 6m³/h 21 mb or 27 mb.
- Ideal solution for flush mounted in situations of limited height. See CA0970 standard.

ADVANTAGES

- Solution of replacement for the old version of the horizontal renovation cabinet (8500960).
- Easy connection due to a large working width.
- Suitable for flush mounted in a wall with the new generation of S2400 type of cabinet.
- Modern and consistent design with the new generation of S2400 type or with the new low-voltage network and public lighting cabinets.



XA301



XA304

EXAMPLES OF INTEGRATION



DESCRIPTION

CABINET MATERIAL:

- Molded cabinet made of polyester reinforced with fiberglass.

CABINET COLOR:

- Ivory RAL 1015.

WIDTH*HEIGHT*DEPTH (MM):

- 428 x 364 x 204.

LOCK:

- Locking device operated by rectangular key.

DOOR:

- Opens up to 90 degrees to the right and equipped with a removal system for easy access to the contents of the cabinet.

CABINET PAINT:

- Surface preparation (cleaning with solvent, light sanding with fine sandpaper).
- Painting with a special plastic primer, then use an exterior finishing paint.

INTERNAL EQUIPMENT:

- 1 brass valve MPB type E1/ 15 gauge (84 03 036).
- 1 pressure regulator 21 mb or 27 mb / b6 N gauge (84 50 123 or 84 50 126).
- 90-degree JPC bend / 20 gauge (82 21 189).
- Outlet connection for renovation cabinet/ 20 gauge (8234 110).
- Not supplied: 110 mm G4 meter and flat meter gasket DN 20.

PROTECTION RATING:

- IP43 according to EN 60529.
- IK10 according to EN 62262.

REFERENCES

CODE	DESIGNATION	GRDF REFERENCE
XA301	HORIZONTAL RENOVATION CABINET B6 N – PE15/CU22 21 MB	85 00 967
XA302	HORIZONTAL RENOVATION CABINET B6 N – PE15/CU22 27 MB	85 00 969
XA300	EMPTY HORIZONTAL RENOVATION CABINET	85 00 964
XA304	DOOR FOR HORIZONTAL RENOVATION CABINET	85 00 965

GAS CABINET

HORIZONTAL RENOVATION ADAPTATION KIT FOR SMART METER

Video
www.pch-sas.com



USAGE

- Allows the modification of an already flush mounted horizontal renovation cabinet (GRDF codes 85 00 962 and 85 00 963) for the integration of a new electronic gas meter without changing the entire cabinet.



XA303

ADVANTAGES

- Adaptation of the kit for all flush mounted horizontal renovation cabinets with a height greater than or equal to 60 mm compared to the finished-floor level.
- Allows the deployment of a smart meter without changing the already flush mounted vat.
- Quick implementation.
- Allows to maintain the gas connection at a location where the available height is limited.
- Reduced cost.
- Reliability of the solution in the long term.

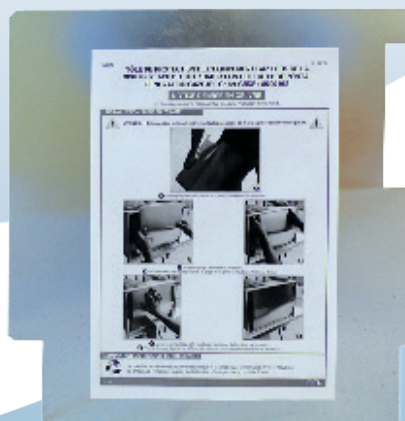

XA305

DESCRIPTION

CABINET MATERIAL:

- Polyester reinforced with fiberglass.

CABINET COLOR:

- Ivory RAL 1015.

WIDTH*HEIGHT*DEPTH (MM):

- Door: 414 x 356 x 47
- Protective steel sheet: 361 x 355 x 1

LOCK:

- Locking device operated by rectangular key.

DOOR:

- Opens up to 90 degrees to the right and equipped with a removal system for easy access to the contents of the cabinet.

CABINET PAINT:

- Surface preparation (cleaning with solvent, light sanding with fine sandpaper).
- Painting with a special primer for plastic, then use an exterior finishing paint.

KIT COMPOSITION:

- 1 still hinge.
- 1 removable hinge.
- 1 removable hinge lock.
- 2 self-drilling screws PH 3.9*32 mm.
- 2 TR plastic screws 4*12 mm.
- 1 door.
- 1 lock.
- 1 cover.
- 1 wall-cutting template.
- 1 spiral sleeve for protection of the PE gas pipe.

PROTECTION OF THE GAS EQUIPMENT IN THE HORIZONTAL RENOVATION CABINET DURING THE INSTALLATION OF THE XA303 KIT:

- Use of the mandatory mechanical protective steel sheet (MCOF352).

REFERENCES

CODE	DESIGNATION	GRDF REFERENCE
XA303	SMART METER ADAPTATION KIT - HORIZONTAL RENOVATION CABINET	85 00 966
XA305	PROTECTION STEEL SHEET FOR MOUNTING THE SMART METER CONVERSION KIT (SALES UNIT: 10)	85 00 972
XA306*	HORIZONTAL RENOVATION CABINET REMOVABLE DOOR	85 00 992

* Product subject to quotation.

GAS CABINET



MISCELLANEOUS CABINETS AND ACCESSORIES

REFERENCES

CODE	DESIGNATION	GRDF REFERENCE
XA500	KEY FOR RECTANGLE HOLES 5X10 + SQUARE M14	84 33 538
XA501	KEY FOR TRIANGLE M11 + SQUARE M14	84 33 542
XA502	S200 GREY DOOR	85 00 270
XA506	S2200 IVORY DOOR	85 00 554
XA507	GAS CABINET TRIANGULAR LOCK	85 00 990
XA508	GAS CABINET RECTANGULAR LOCK	85 00 991
XA509	S50 HIGH CABINET WITH CONNECTION TERMINAL	86 01 106
XA510	GREY DOOR FOR S250 WITH SMART METER	85 00 273
XA514	IVORY DOOR FOR S2200 WITH VALVE ACCESS	85 00 556
X795	REPAIR KIT FOR S200-S250 CABINET LOCK	85 02 026
X796	STRIKER AND STOP FOR S300 LOCK WITH SCREWS (PACK OF 50)	85 02 030



XA510

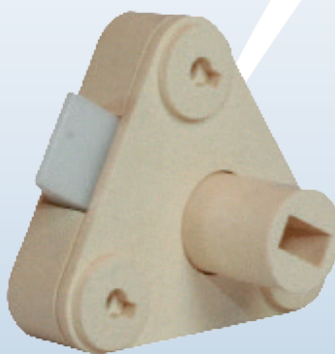

XA508



3 functions gas key

ADAPTOR KIT FOR CABINET SUPPORTS

USAGE

- Cabinet changeover for different center-to-center distances, without the need for new concrete.
- In the case of identical center-to-center distances, the kit also allows the alignment of the cabinet to be changed.

ADVANTAGES

- Kit compatible with all cabinet brands, regardless of the size and generation.
- Avoids the need for an excavation overhaul.
- Adaptable to already sealed supports.
- Easy and simple cabinet replacement.
- Compatible with all support layout S2300, S2400, S22, S300.



DESCRIPTION

MATERIALS USED:

- PVC cone sockets.
- Bolts: galvanized steel and stainless steel.

COMPOSITION:

- 4 adaptor plates.
- 8 cone sockets 32 mm diameter.
- 8 cone sockets 40 mm diameter.

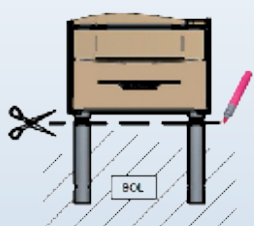

1 • Cut the supports to be replaced at the appropriate level.

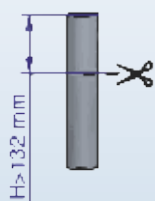

2 • Cut the supports of the new cabinet, leaving at least 132 mm.

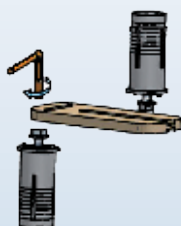

3 • Choose the appropriate cone sockets and assemble them with the adaptor plates without locking them.

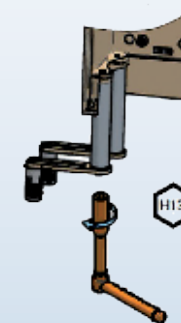
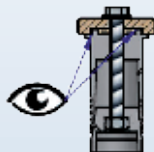

4 • Fix the supports to the cabinet and then insert the 4 cone sockets.

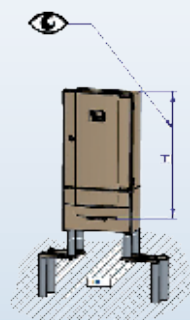

5 • Align the adaptor plates and adjust the center distances to match the existing supports.

REFERENCE

CODE	DESIGNATION	GRDF REFERENCE
X799	ADAPTOR KIT FOR CABINET SUPPORTS Ø 32 ET Ø 40	85 00 982



EXTENSION KIT FOR CABINET SUPPORTS

USAGE

- Repair of cabinet supports when their supports blocked in concrete are broken.
- Raising of cabinet during the refurbishment of sidewalks or roadways.
- Can only be used if the breakage of the supports is less than 250 mm from the point of support of the cabinet.
- Compatible with all cabinets with $\varnothing 32$ or $\varnothing 40$ mm supports.

ADVANTAGES

- Adaptable on pre-sealed supports.
- Avoids the full resumption of the excavation.
- Easy positioning in the existing supports.
- Quick and simplified cabinet replacement.
- Easy to implement.

DESCRIPTION

MATERIALS USED:

- Cone sockets: PVC.
- Supports: PVC.
- Bolts: steel.
- Other parts: PVC.

COMPOSITION:

- 4 supports of length 250 mm.
- 4 cone sockets.
- 4 threaded rods of length 347 mm.
- 4 washers / 4 acorn nut / 4 tube caps.



Supports $\varnothing 40$ or $\varnothing 32$ mm
L 250 mm

Centering ring
 $\varnothing 40$ or $\varnothing 32$ mm

Cone sockets
 $\varnothing 40$ or $\varnothing 32$ mm

M8 threaded rod L347 mm
+ washer + acorn nut

Tube cap:
 $\varnothing 40$ or $\varnothing 32$ mm

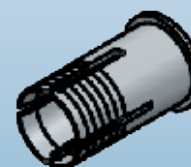
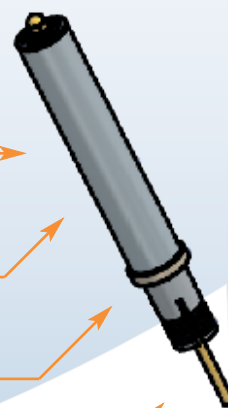

IMPLEMENTATION

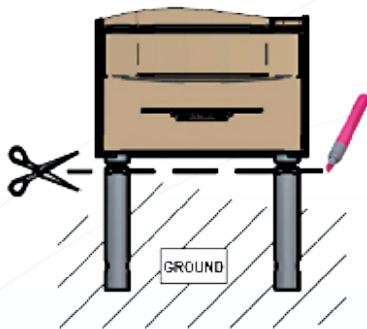

- 1 • Cut the supports that need to be replaced at the right level.

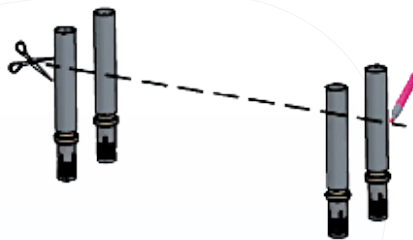

- 2 • Mark and cut the supports at the right level.

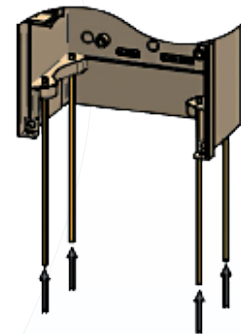

- 3 • Remove the acorn nuts and washers. Place the threaded rods through the vat.

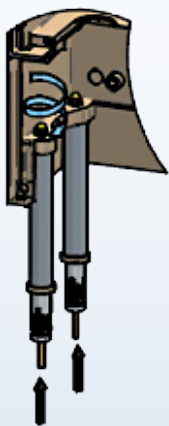

- 4 • Replace the washers and the acorn nuts. Pre-screw by hand the supports and the cone sockets onto the threaded rods.

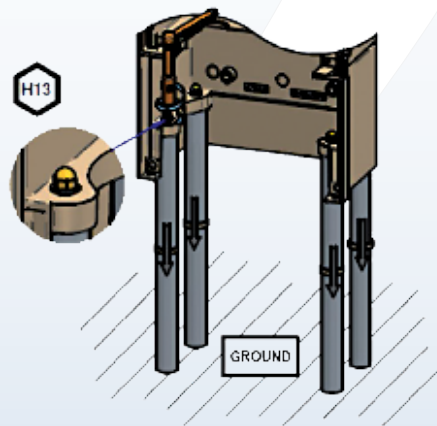

- 5 • Mount the box equipped with its repair kit onto the previously cut supports and tighten the threaded rods tightly.

REFERENCES

CODE	DESIGNATION	GRDF REFERENCE
X797	Ø 32 REPAIR CABINET SUPPORTS KIT	85 00 980
X798	Ø 40 REPAIR CABINET SUPPORTS KIT	85 00 981

TECHNICAL ENCLOSURES

OUTDOOR GAS TECHNICAL ENCLOSURE

USAGE

- The outdoor gas technical enclosure allow the installation of 3 to 10 G4 gas meters. They are used to connect apartment buildings to gas distribution networks. Their main advantage is to connect several customers to a single connection point.
- The outdoor gas technical enclosures are available with regulators (21, 27 and 37 mbars) or without regulators for connection to low-pressure networks, with or without base.

DESCRIPTION

ENCLOSURE COMPONENTS:

- Aluminium base.
- Aluminium enclosure with ventilated door.
- Certified NF ROB-GAZ valve.
- Grounding kit (optional).
- Mounted shut-off bar (optional).

ENCLOSURE MATERIALS:

- Painted aluminium enclosure and base.
- Copper pipe.
- Brass fittings.

COLORS:

- Ivory RAL 1015.

WIDTH*HEIGHT*DEPTH (MM):

- Enclosures for 3-4-5 meters: 690*800*250.
- Enclosures for 6-8 meters: 1100*800*250.
- Enclosures for 10 meters: 1300*800*250.

LOCK:

- Rectangular lock.

PROTECTION RATING:

- IP33 according to EN 60529.
- IK10 according to EN 62262.



Outdoor gas technical enclosure



REFERENCES

DESIGNATION	WITHOUT BASE		WITH BASE	
	CODE	GRDF REFERENCE	CODE	GRDF REFERENCE
PTG 3 METERS MPB-21MBAR	XE210	85 01 101	XE213	85 01 111
PTG 3 METERS MPB-27MBAR	XE211	85 01 141	XE214	85 01 151
PTG 3 METERS MPB-37MBAR	XE212	85 01 161	XE215	85 01 171
PTG 3 METERS LP	XE216	85 01 121	XE217	85 01 131
PTG 4 METERS MPB-21MBAR	XE218	85 01 102	XE221	85 01 112
PTG 4 METERS MPB-27MBAR	XE219	85 01 142	XE222	85 01 152
PTG 4 METERS MPB-37MBAR	XE220	85 01 162	XE223	85 01 172
PTG 4 METERS LP	XE224	85 01 122	XE225	85 01 132
PTG 5 METERS MPB-21MBAR	XE226	85 01 103	XE229	85 01 113
PTG 5 METERS MPB-27MBAR	XE227	85 01 143	XE230	85 01 153
PTG 5 METERS MPB-37MBAR	XE228	85 01 163	XE231	85 01 173
PTG 5 METERS LP	XE232	85 01 123	XE233	85 01 133
PTG 6 METERS MPB-21MBAR	XE234	85 01 104	XE237	85 01 114
PTG 6 METERS MPB-27MBAR	XE235	85 01 144	XE238	85 01 154
PTG 6 METERS MPB-37MBAR	XE236	85 01 164	XE239	85 01 174
PTG 6 METERS LP	XE240	85 01 124	XE241	85 01 134
PTG 8 METERS MPB-21MBAR	XE242	85 01 105	XE245	85 01 115
PTG 8 METERS MPB-27MBAR	XE243	85 01 145	XE246	85 01 155
PTG 8 METERS MPB-37MBAR	XE244	85 01 165	XE247	85 01 175
PTG 8 METERS LP	XE248	85 01 125	XE249	85 01 135
PTG 10 METERS MPB-21MBAR	XE250	85 01 106	XE253	85 01 116
PTG 10 METERS MPB-27MBAR	XE251	85 01 146	XE254	85 01 156
PTG 10 METERS MPB-37MBAR	XE252	85 01 166	XE255	85 01 176
PTG 10 METERS LP	XE256	85 01 126	XE257	85 01 136
OPTIONS				
EQUIPPED EARTHING KIT	XE258	84 60 160		
MOUNTED AND CONNECTED SHUT-OFF VALVE	XE259	85 01 002		

KITCHEN SUPPLY TECHNICAL ENCLOSURE

USAGE

- These enclosures are installed in buildings without individual meters.
- The system are offered in an enclosure or on a steel sheet for an inside application without metering.

DESCRIPTION

ENCLOSURE COMPONENTS:

- Aluminium base (optional).
- Aluminium bottom lock plate (optional).
- Aluminium enclosure with ventilated door.
- Certified NF ROB-GAZ valve.

ENCLOSURE MATERIALS:

- Steel plate.
- Painted aluminium enclosure and base.
- Copper pipe.
- Brass fittings.

COLORS:

- Ivory RAL 1015.

WIDTH*HEIGHT*DEPTH (MM):

- Enclosure: 690 x 750 x 250.

LOCK:

- Rectangular lock.

PROTECTION RATING:

- IP33 according to EN 60529.
- IK10 according to EN 62262.

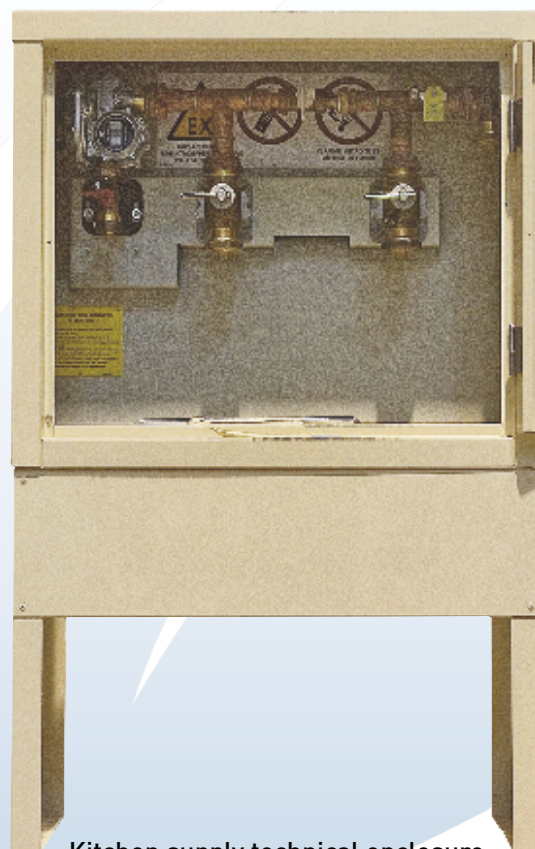

Kitchen supply technical enclosure

NEW

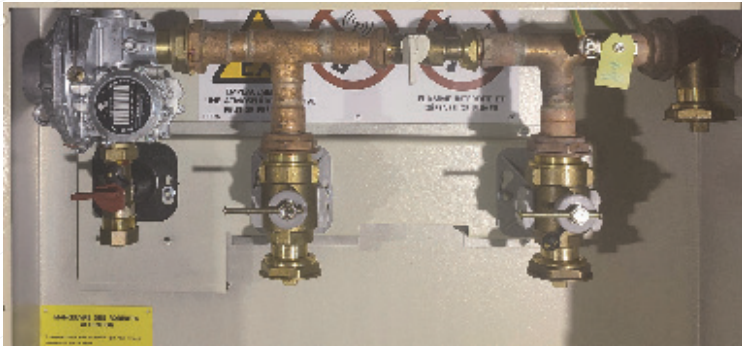

XE261 - Interior view



**XE260
to
XE263**



XE266

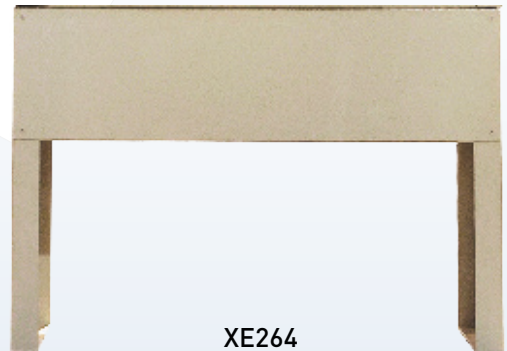

XE264

REFERENCES

CODE	DESIGNATION	GRDF REFERENCE
XE260	KITCHEN ENCLOSURE MP B10-E1A	85 01 180
XE261	KITCHEN ENCLOSURE MP B25-E1A	85 01 181
XE262	KITCHEN ENCLOSURE LP-E1A	85 01 182
XE263	KITCHEN ENCLOSURE LP-EA	85 01 183
XE264	KITCHEN ENCLOSURE BASE	85 01 184
XE265	BOTTOM LOCK PLATE	85 01 185
XE266	MOUNTED FITTING WITHOUT METER G6	85 01 186
XE267	MOUNTED FITTING WITHOUT METER G4	85 01 187



UNDERGROUND NETWORK STATIONS WITH DOUBLE TAPPING

USAGE

- These underground stations supply gas to a low-pressure network branch.

ADVANTAGES

- These systems allow the installation of a bypass to keep customers supplied with gas.
- The regulators are installed in a high position in the cabinet to facilitate maintenance operations.
- The same casing and interior components can be used to switch from an R100 to an R25 model, by changing the regulator and fitting an adaptor bracket.

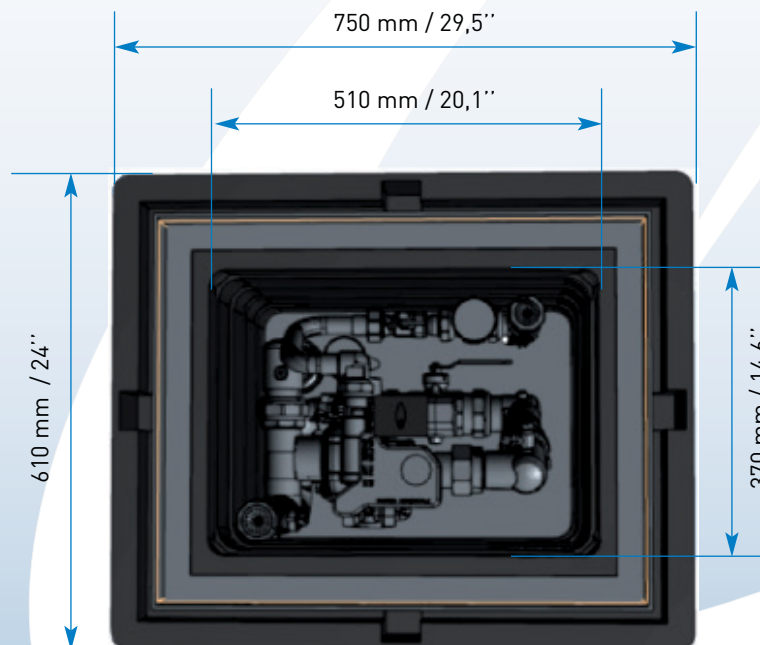

DESCRIPTION

- Thermoplastic vat.
- C250 cast iron manhole cover according to the EN 124-2.
- Network regulator R100E or R25E depending on the version.
- All internal components are approved by GRDF.

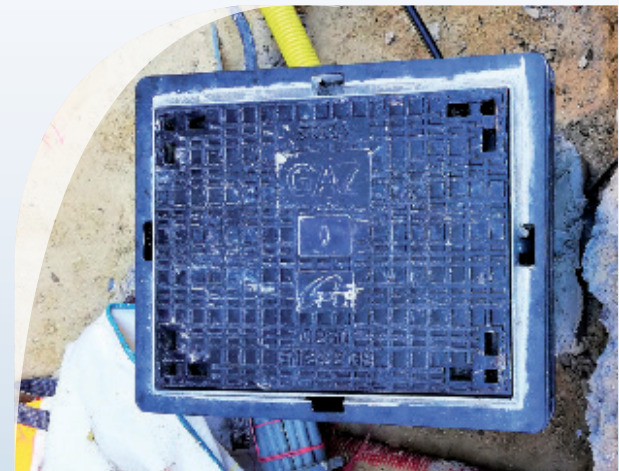

REFERENCES

CODE	DESIGNATION
XE800	UNDERGROUND R25E PRESSURE REGULATING STATIONS WITH DOUBLE CONNECTION
XE801	UNDERGROUND R100E PRESSURE REGULATING STATIONS WITH DOUBLE CONNECTION
XE802	R100E - R25E CONVERSION KIT

DELIVERY STATIONS

LOW PRESSURE METERING ONLY CUSTOMER STATIONS FROM 25 TO 65 M³/H (GROUP 5)

USAGE

- These customer stations allow for low-pressure gas metering with flow rates from 25 to 65 m³/h at 21 or 27 mbar. (Group 5).

ADVANTAGES

- Compatible with all meter brands for maintenance purposes.
- Can be installed in cabinets or on frames.
- Multiple customization options available.

DESCRIPTION

METERING BLOCK:

- DN50 input butterfly valve.
- Diaphragm meter G16, G25, or G40.
- Pressure gauge with pressure valve.
- DN50 outlet butterfly valve.

CONNECTION (OPTIONAL):

- DN50 insulating flange connection (delivered assembled).
Or
- Mechanical compression fitting for PE63 (delivered assembled).
Or
- Electrofusion metal/plastic transition fitting for PE63.

CABINET:

- Aluminum cabinet with ventilated door and access hatch to input valve.
- Triangle key lock.
- Lifting plates.
- IP33 and IK10 rated.

WIDTH * HEIGHT * DEPTH IN MM (INCHES):

- V900A cabinet: 900*1100*500 mm (35.4"x43.3"x19.7").
- V1100 cabinet: 1100*1600*800 mm (43.3"x63"x31.5").
- V900A frame: 900*950*500 mm (35.4"x37.4"x19.7").
- V1100A frame: 1100*1150*800 mm (43.3"x45.3"x31.5").

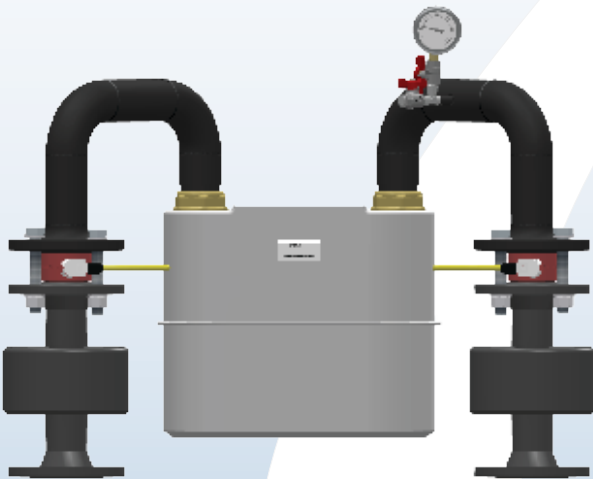

REFERENCES

CODE	DESIGNATION	GRDF NOMENCLATUR
XE664	GR5 25M3 21 OR 27MB V900A	84 58 010
XE669	GR5 40M3 21 OR 27MB V900A	84 58 020
XE674	GR5 65M3 21 OR 27MB V1100	84 58 030

OPTIONS

CODE	DESIGNATION	GRDF REFERENCE
XE647	CABINET V900A	84 60 010
XE734	CABINET V1100	84 60 024
XE648	SOUNDPROOF CABINET V900A	84 60 293
XE731	SOUNDPROOF CABINET V1100	84 60 300
XE649	STAND V900A	84 60 112
XE736	STAND V1100	84 60 118
XE650	FRAME V900A	84 60 011
XE740	FRAME V1100	84 60 028
XE724	CABINET COLOR PACKAGE	84 60 241
XE725	STAND COLOR PACKAGE	84 60 242
XE726	ANTI-GRAFFITI PACKAGE	84 60 243
XE727	ANTI-POSTER PACKAGE	84 60 244
XE729	INPUT INSULATING FITTING DN50 PN16	84 60 142
XE730	INPUT MET.PLA MEC PE63/DN50	84 60 120
XE790	INPUT MET.PLA E-S PE64/DN50	84 60 123
XE717	OUTLET INSULATING FITTING DN50	84 60 191
XE718	OUTLET MET.PLA MEC PE63/DN50	84 60 170
XE719	OUTLET MET.PLA E-S PE63/DN50	84 60 172
XE258	EQUIPPED GROUNDING KIT	84 60 160

PRESSURE REGULATING STATIONS

NETWORK STATION MLP/LP TYPE R OR TYPE D FROM 25 TO 160 M³/H (GROUP 6)

USAGE

- These network stations supply a low pressure microgrid from a MLP network (400 mbar to 4bar).
- Flow ranges from 25 to 160 m³/h in a single line with type R regulator.
- Flow ranges from 100 to 160 m³/h in single and double line with direct-acting regulator.

ADVANTAGES

- Can be installed in cabinets or on frames.
- Multiple customization options available.



(Example: group 6A station 160 m³/h Type R)

DESCRIPTION

PRESSURE REDUCTION BLOCK

	Groupe 6A			Groupe 6B		
Type	25m ³ /h type R 21 or 27mbar	100 m ³ /h type R 21 or 27mbar	160 m ³ /h Type R 21 ou 27mbar	100 m ³ /h Direct-acting 21 ou 27mbar	160 m ³ /h Direct-acting 21 ou 27mbar	160 m ³ /h Direct-acting Double ligne 21 ou 27mbar
Input	Mechanical compression metal/plastic fitting for PE32		Mechanical compression metal/plastic fitting for PE40	Mechanical compression metal/plastic fitting for PE32	Mechanical compression metal/plastic fitting for PE40	DN50 Flange PN16
	DN25 Valve					
Regulator	R25 21 ou 27mbar	R100 21 ou 27mbar	R100 21 ou 27mbar (x2)	Direct action 100 m ³ /h 21 or 27mbar	Direct action 160 m ³ /h 21 or 27mbar	Direct action 160 m ³ /h 21 or 27mbar (x2)
Output	DN50 Butterfly Valve					DN80 butterfly valve (x2)
	DN50 flange PN16		DN100 flange PN16	DN50 flange PN16	DN100 flange PN16	

OUTLET CONNECTIONS:

- Insulating flange connection DN50 or DN100 depending on the model.
- Metal/Plastic electrofusion transition fitting PE63 or PE110 depending on the model.

SMALL EQUIPMENT:

- Pressure gauge with pressure valve and/or purge valve depending on the model.
- Equipotential bonding with disconnection strip.

CABINET:

- Aluminum cabinet with ventilated door and access hatch to input valve.
- Triangle key lock.
- Lifting rings or plates depending on the model.
- IP33 and IK10.

DIMENSIONS (WIDTH * HEIGHT * DEPTH IN MM / INCHES):

- Cabinet or frame V600A: 600*1100*350 mm (23.6"x 43.3"x 13.8").
- Cabinet or frame V600B: 600*1200*450 mm (23.6"x 47.2"x 17.7").
- Cabinet or frame V700: 700*1400*400 mm (27.6"x 55.1"x 15.7").
- Cabinet V1300: 1300*1800*700 mm (51.2"x 70.9"x 27.6").

PRESSURE REGULATING STATIONS

REFERENCES

CODE	DESIGNATION	GRDF REFERENCE
XE679	GR6A R25 21MB V600A	84 55 169
XE680	GR6A R25 27MB V600A	84 55 170
XE685	GR6A R100 21MB V600A	84 55 153
XE686	GR6A R100 27MB V600A	84 55 155
XE691	GR6A DOUBLE R100 21MB V700	84 55 163
XE692	GR6A DOUBLE R100 27MB V700	84 55 161
XE697	GR6B 100M3 DA 21MB V600B	84 55 152
XE698	GR6B 100M3 DA 27MB V600B	84 55 154
XE703	GR6B 160M3 DA 21MB V700	84 55 162
XE704	GR6B 160M3 DA 27MB V700	84 55 164
XE709	GR6B 160M3-DL DA 21MB V1300	84 55 165
XE710	GR6B 160M3-DL DA 27MB V1300	84 55 166

OPTIONS

CODE	DESIGNATION	GRDF REFERENCE
XE681	CABINET V600A	84 60 365
XE627	CABINET V600B	84 60 007
XE693	CABINET V700	84 60 367
XE735	CABINET V1300	84 60 050
XE682	SOUNDPROOF CABINET V600A	84 60 308
XE628	SOUNDPROOF CABINET V600B	84 60 285
XE694	SOUNDPROOF CABINET V700	84 60 310
XE732	SOUNDPROOF CABINET V1300	84 60 290
XE683	STAND V600A	84 60 412
XE629	STAND V600B	84 60 110
XE695	STAND V700	84 60 135
XE737	STAND V1300	84 60 132
XE617	FRAME V600A	84 60 001
XE630	FRAME V600B	84 60 002
XE696	FRAME V700	84 60 382
XE724	CABINET COLOR PACKAGE	84 60 241
XE725	STAND COLOR PACKAGE	84 60 242
XE726	ANTI-GRAFFITI PACKAGE	84 60 243
XE727	ANTI-POSTER PACKAGE	84 60 244
XE729	INPUT INSULATED FITTING DN50 PN16	84 60 142
XE730	INPUT M.P MEC PE60/DN50	84 60 120
XE717	OUTLET INSULATED FITTING DN50 PN16	84 60 191
XE719	OUTLET M.P I-O PE63/DN50	84 60 172
XE720	OUTLET INSULATED FITTING DN100 PN16	84 60 193
XE721	OUTLET M.P I-O PE110 /DN100	84 60 175
XE722	SINGLE LINE VENT WIRING	84 60 245
XE881	DOUBLE LINE VENT WIRING	84 60 246
XE258	EQUIPPED GROUNDING KIT	84 60 160





NETWORK PROTECTION

● MECHANICAL PROTECTION

Meter board for building network.....	46
Tubing system.....	48
HDPE gas network cover plates.....	50
Protective riser sleeves and gas bends.....	52
All-in-one universal sleeve and bend.....	53
PE sealing caps.....	54
Aluminium tube protection cover.....	56
Pipe casing spacers.....	57
Equipment for securing branch valves.....	58





METER BOARD FOR BUILDING NETWORK

USAGE

- This meter board serves as a support for the meter during the installation of the rising column and ensures its installation in compliance with the rules of the trade.
- It supports the weight of the meter, without any constraint on the upstream welds and independently of the connected outlet.

ADVANTAGES

The meter board allows to guarantee the following points:

- The installation and removal of the meter without stressing the welds.
- The center distance between the entry and exit of the gas meter (110 mm).
- The elevation of the two inlet/outlet connections.
- The location of the gas company identification plate.
- The installation of the shunt duct.
- Downstream meter compatibility in both copper and PLT.

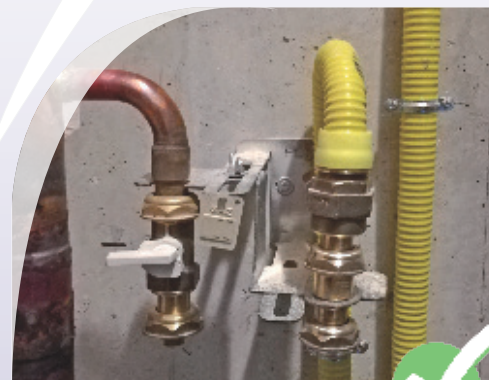

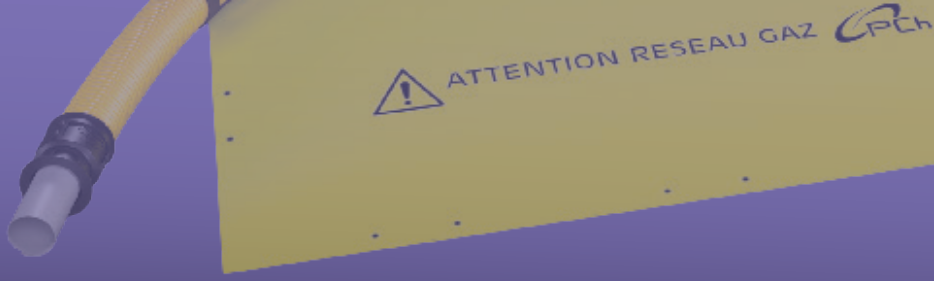

DESCRIPTION

MATERIAL:

- Galvanized steel sheet.

COMPONENTS:

- Fixed plate for wall mounting.
- Adjustable plate.
- Captive screws.
- Brass fitting for customer network output with copper or PLT swan neck connector.
- Fixing accessories included.

WIDTH*HEIGHT*DEPTH (MM):

- 160 x 110 x 170.

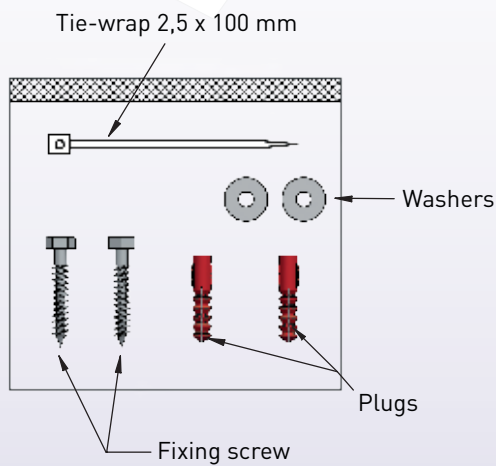
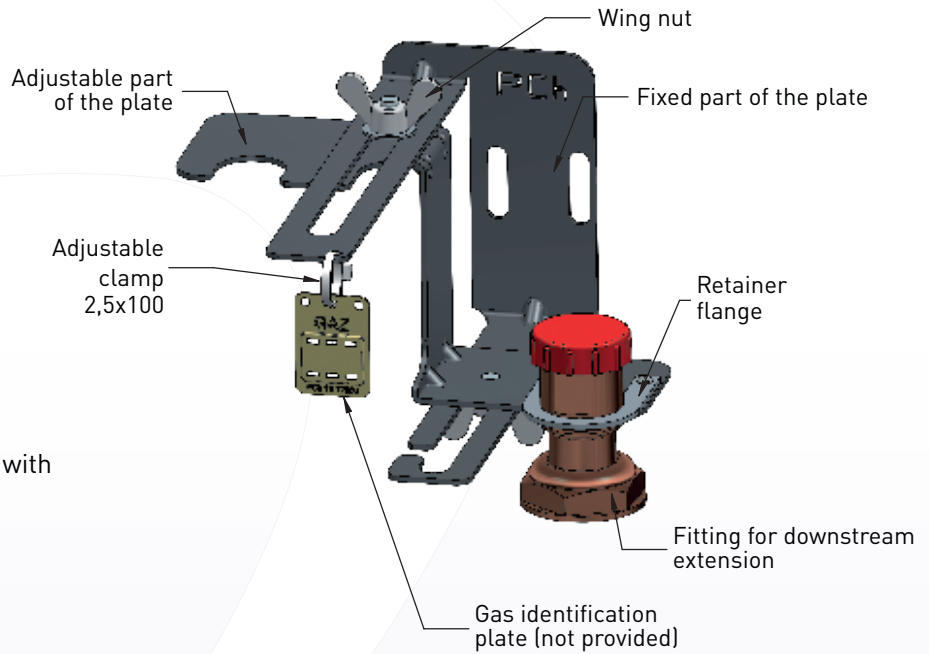

REFERENCE

CODE	DESIGNATION	GRDF REFERENCE
XE001*	METER MOUNTING PLATE	82 21 222

* Product subject to quotation.

MECHANICAL PROTECTION



TUBING SYSTEM

 **Video**
www.pch-sas.com



USAGE

- Centering and protection of the PE gas pipe during the tubing operation.

ADVANTAGES

- Protects against injuries caused by the ends of the metal pipe during the tubing operation.
- Prevents sand from flowing into the tubed pipe while allowing the escape of any gas leaks. Mandatory to prevent road collapses.
- Easy to install and durable (cone retention system).
- Eco-production: made from recycled materials.
- The kit of 10 tubing systems includes all the components needed for installation:
 - 10 cones or shells.
 - 10 installation kits (fixing brackets and strap).
 - 10 covers.
 - 1 guide tool.



X251



X252



X253

Ø Minimal interior of the sleeve (in mm)	Ø Minimum allowed interior diameter			PE 40	PE 63	PE 110	PE 125	PE 160	PE 200
	Cast iron Øint/ext	Steel Øint/ext	Bituminous metal sheet Øint/ext						
80		82/89	81/83	Casing cone for					
100	105/118	107/114	108/110	PE63 into pipe 80-100					
150	157/170	161/168	162/164	Casing cone for					
200	209/222	212/219	216/218	PE125 into pipe 150-200					
250	312/324	316/326	300/304	Casing shell for					
300 (*)				PE200 into pipe 250-400					

* The shell is sized for the sleeve casing up to 400 mm of internal diameter.

DESCRIPTION

CONES AND SHELLS:

- Injected thermoplastic.
- Two identical half-shells per diameter.
- Entrance flange to facilitate the penetration of the PE during piping.
- Longitudinal ribs to ensure degassing in case of leakage.

CONE (X255) OR SHELL (X256) INSTALLATION KIT:

- 4 fixation lugs (model adapted according to a cone or shell installation).
- 1 locking strap (X255 : 2m, X256 : 5m).

BACKFILL INTRUSION PROTECTION SYSTEM: GEOTEXTILE COVER:

- 2 models : one for cone (X257) and one for shell (X258).
- Geotextile cover + tie-wraps.

GUIDE TOOL:

- Two thermoplastic half-shells and two assembly screws.
- Allows the guiding and centering of the pulling cable.

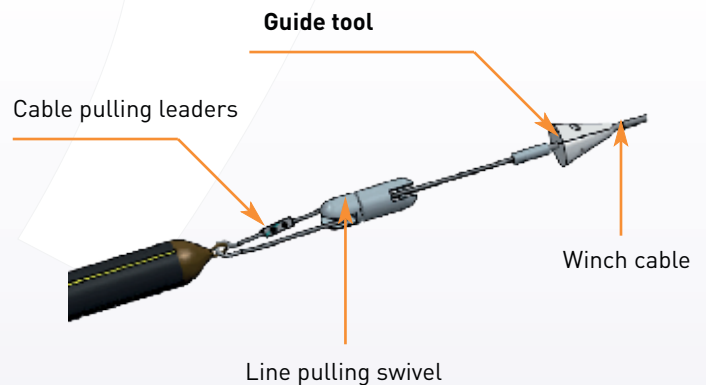
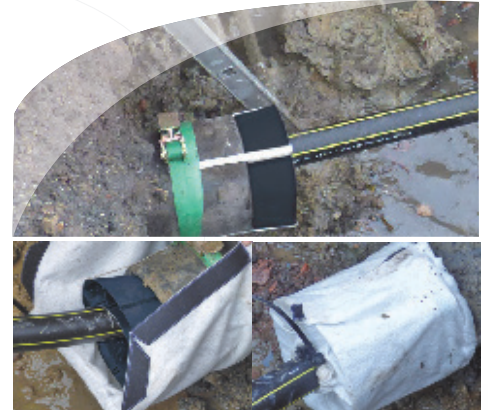

REFERENCES

CODE	DESIGNATION	GRDF REFERENCE
X251	PE63 CASING CONE / 80-100 SLEEVE	86 20 461
X252	PE125 CASING CONE /150-200 SLEEVE	86 20 462
X253	PE200 CASING SHELL / 250-400 SLEEVE	86 20 468
X255	CONE INSTALLATION KIT	86 20 469
X256	SHELL INSTALLATION KIT	86 20 471
X257	GEOTEXTILE COVER FOR CONE	86 20 470
X258	GEOTEXTILE COVER FOR SHELL	86 20 472
X259	GUIDING TOOL FOR CASING CONE/SHELL	86 20 473
X254	10 PE 63 TUBING KIT / 80-100 SLEEVE	86 20 474
X260	10 PE125 TUBING KIT / 150-200 SLEEVE	86 20 475
X261	10 PE200 TUBING KIT / 250-400 SLEEVE	86 20 476



HDPE GAS NETWORK COVER PLATES

USAGE

- Protection against transverse and longitudinal pulling of buried gas pipelines.
- Used for pipe under infrastructures or in areas with high density of buried structures.
- Suitable for all distribution pipelines with a maximum operating pressure (MOP) of 4 bar (medium pressure) or polyethylene pipelines with a maximum operating pressure of 8 bar (high pressure).
- Effectively replaces the use of concrete to protect gas pipes, making it possible to intervene again if necessary.

DESCRIPTION

MATERIAL USED:

- Virgin HDPE (high-density polyethylene) compliant with EN I 1872-1 standard.

THICKNESS:

- 15 mm.

OPERATING TEMPERATURE RANGE:

- -25°C to +50°C.

DENSITY:

- > 930 kg/m³.

MINIMUM LIFESPAN:

- 60 years (regulatory requirements).

COUPLING:

- Longitudinal and T-shaped by jumper link.

COLOR:

- Yellow (mass-colored HDPE).

ADVANTAGES

- Easier detection and identification of the network during excavation.
- Provides permanent and durable mechanical protection.
- Easy to transport and install, especially compared with concrete protection.
- Easy to store.

Complementary product Underground Warning Mesh



- This product is certified and meets the EN 12613 standard.
- Supplied in rolls 100 meters long and 30 cm wide.

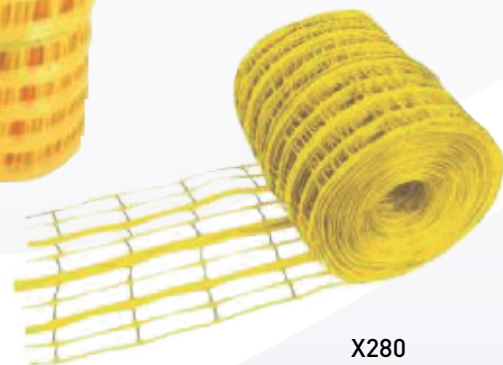

X280



RESISTANCE

- Resistance to vertical impacts without perforation (test with an 18-ton mechanical excavator bucket falling from a height of 100cm).
- Resistance to longitudinal excavation impacts.
- Transverse protection of the pipeline (no access to the pipe).

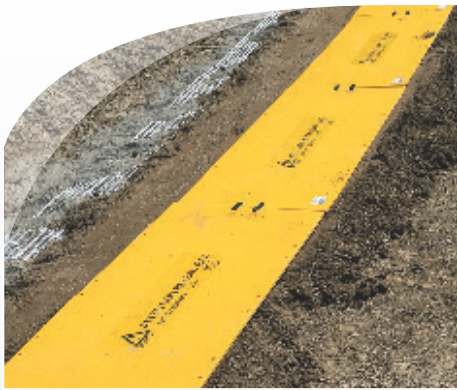

REFERENCES

CODE	DESIGNATION	EXTERNAL DIAMETER of the MPB pipeline to be protected	EXTERNAL DIAMETER of the PE, MPC pipeline to be protected	EXTERNAL DIAMETER of the steel MPC pipeline to be protected	GRDF NOMENCLATURE
X010	PPR 50050 GAZ	CAN BE USED TO COMPLEMENT THE PROTECTION OF THE EXCAVATION AND AVOID CUTTING OTHER PLATES			86 23 128
X012	PPR 50150 GAZ	Customer connection up to diameter 40 and network in diameter 40			86 23 123
X013	PPR 57150 GAZ	Ø EXT. < 70	Ø EXT. < 70		86 23 124
X014	PPR 72150 GAZ	Ø EXT. < 220	Ø EXT. < 165	Ø EXT. < 120	86 23 125
X015	PPR 82150 GAZ	Ø EXT. < 420		Ø EXT. < 220	86 23 126
X016	PPR 101150 GAZ			220 ≤ Ø EXT. ≤ 410	86 23 127
X011	JUMPER LINK PPR GAZ 15 MM				86 23 122
X280	YELLOW UNDERGROUND WARNING MESH 30 CM 100 M				



PROTECTIVE RISER SLEEVES AND GAS BENDS

USAGE

- Protection and guidance of PE gas pipes (compliance with the minimum bending radius, mandatory when installing gas cabinets or boxes).

ADVANTAGES

- Mechanical, thermal, permanent and unalterable protection.
- Eco-production: made from recycled materials.

DESCRIPTION

MATERIAL USED:

- PVC (Polyvinyl chloride).

FEATURES:

- Rigid tube for gas networks.

COLOR:

- Yellow.

COMPLIANT WITH IMPACT TEST:

- According to EN 1411 standard, 20 J at 0°.

REFERENCES



Bayonet sleeve



Straight sleeve



Gas bend 90 degrees

CODE	DESIGNATION	DIAMETER	GRDF REFERENCE
X224	YELLOW BAYONET SLEEVE Ø 50 50 86 20 403	50	86 20 403
X225	YELLOW CURVED SLEEVE Ø 50 SELF-LOCKING	50	86 20 353
X227	Ø 50 YELLOW GAS BEND 90 DEGREES	50	86 20 352
X229	Ø 50 YELLOW STRAIGHT SLEEVE	50	86 20 372
X235	STRAIGHT SLEEVE Ø 50 L= 250 MM (EXTENSION)	50	86 20 380
X236	COUPLING SLEEVE F/F Ø 50 L= 65 MM	50	86 20 385
X226	PVC REDUCTION SLEEVE Ø 63-50	50-63	86 20 420
X223	Ø 63 YELLOW BAYONET SLEEVE	63	86 20 405
X228	Ø 63 YELLOW GAS BEND 90 DEGREES	63	86 20 354
X230	Ø 63 YELLOW STRAIGHT SLEEVE	63	86 20 375
X237	COUPLING SLEEVE F/F Ø 63 L= 78 MM	63	86 20 386

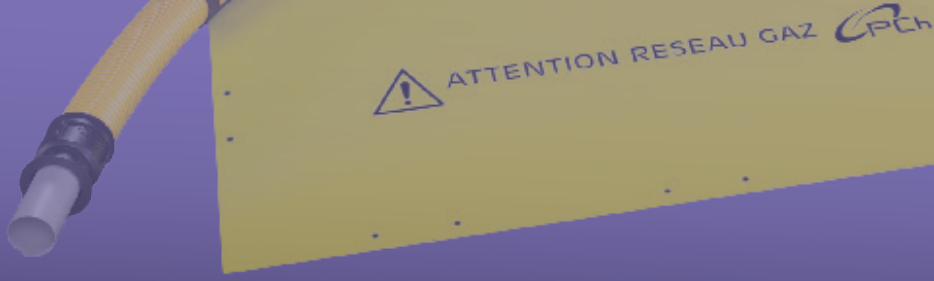

ALL-IN-ONE UNIVERSAL SLEEVE AND BEND

Video
www.pch-sas.com



USAGE

- Protection and guidance of PE gas pipes (compliance with the minimum bending radius, mandatory when installing gas cabinets or boxes).

ADVANTAGES

- Simple and intuitive implementation.
- Uninterrupted protection.
- Blocking system in cabinet entry point: prevents the sleeve from rising during compaction.
- High thermal protection.
- Anti-rodent protection:
 - Prevents the gas pipe from being damaged in the cabinet.
 - The system slides to allow emergency crushing.
- One reference for PE diameters ranging from 20 to 40 mm.
- Reduced environmental impact compared with PVC sleeves and bends.

DESCRIPTION

COMPOSITION:

- Rigid curved recycled HDPE tube.
- High-resistance HDPE corrugated tubing.
- Anti-rodent protection.

COLORS:

- Yellow and black.

PROTECTION RATING:

- IK 10 according to EN 1411 standard.

MATERIAL USED:

- HDPE + recycled HDPE.

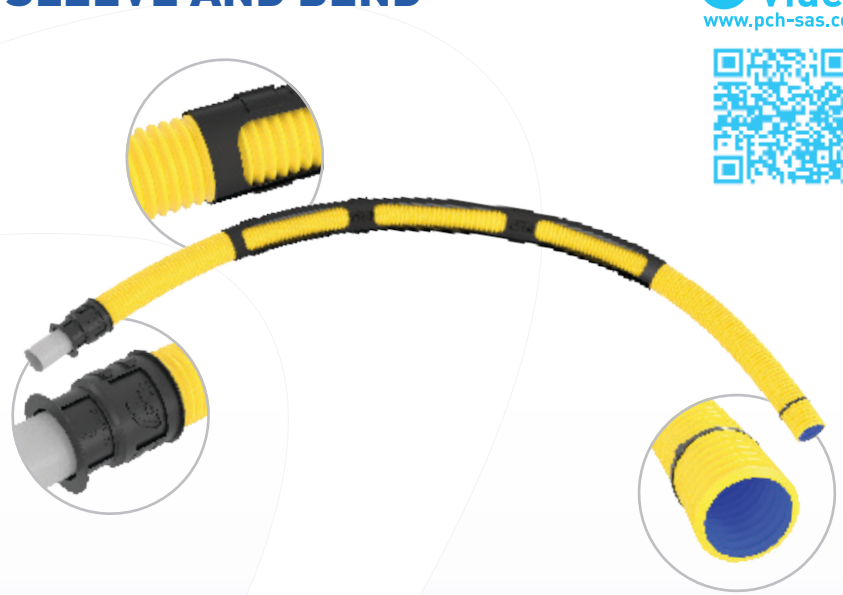

REFERENCE

CODE	DESIGNATION	DIAMETER	GRDF REFERENCE
X238	Ø20 TO Ø 40 PE UNIVERSAL SLEEVE AND BEND	63	86 20 406



PE SEALING CAPS

 **Video**
www.pch-sas.com



Ø: 16 - 27
PE 20
X017

Ø: 26 - 48
PE 32 - 40
X018

Ø: 46 - 80
PE 63
X019

USAGE

- PE gas pipes covering to ensure watertightness during storage, uncoiling and pending connection.
- Sealing of TPC conduits in preparation for pulling or to protect against excessive water or backfill run-off.



PE pipe

REFERENCES

CODE	DESIGNATION	CAPACITY	GRDF REFERENCE
X017	POLYETHYLENE COLD-SHRINKING CAP 20	PE TUBE DIAMETER 20 DIAMETER OF APPLICATION: 16 TO 27 MM (0.63" TO 1.06")	80 10 980
X018	POLYETHYLENE COLD-SHRINKING CAP 32-40	PE TUBE DIAMETER 32 OR 40 DIAMETER OF APPLICATION: 26 TO 48 MM (1.02" TO 1.89")	80 10 981
X019	POLYETHYLENE COLD-SHRINKING CAP 63	PE TUBE DIAMETER 63 DIAMETER OF APPLICATION: 46 TO 80 MM (1.81" TO 3.15")	80 10 982



ADVANTAGES

- Prevents the intrusion of impurities present in the tube's environment before it is put into service.
- Easy, quick installation without tools.
- Flexible elastomer, resistant to various chemical and atmospheric agents (UV, Ozone).
- The kit includes a carrying case, 4 caps of each size, and sealing tapes.



Ø110, Ø125, Ø160
X020



Ø110
X023



Ø125
X022



Ø160
X021

REFERENCES

CODE	DESIGNATION	GRDF REFERENCE
X020	PE SEALING KIT 110-125-160	80 10 983
X021	SET OF 4 SEALING PE CAPS 160	80 10 884
X022	SET OF 4 SEALING PE CAPS 125	80 10 885
X023	SET OF 4 SEALING PE CAPS 110	80 10 886
XD052	SEALING ADHESIVE TAPE 50 MM*10 M (2" X 32.8")	80 10 984



ALUMINIUM TUBE PROTECTION COVER

USAGE

- Metal protective sleeves are used to secure gas pipelines that are accessible along the exterior facades up to a height of 2.75 meters.

ADVANTAGES

- Lightweight.
- Resistant.
- Anti-vandalism.

DESCRIPTION

Metallic sleeve (protective sleeve for pipelines)

MATERIAL USED:

- Aluminium.

PROTECTION RATING:

- IK 10 according to EN 62262.



Metallic (GPC) sleeve

The 

Product delivered with a protective film.

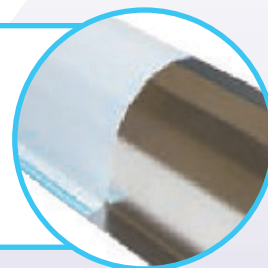

REFERENCES

CODE	DESIGNATION	LENGTH	DIAGRAM	GRDF REFERENCE
X047	METALLIC SLEEVE 35.35	2m75		86 23 190
X048	METALLIC SLEEVE 60.60	2m75		86 23 191
X049	METALLIC SLEEVE 90.90	2m75		86 23 192
X050	METALLIC SLEEVE 120.120	2m75		86 23 193

PIPE CASING SPACERS

USAGE

These casing spacers serve a dual purpose:

- They electrically isolate the pipe from the casing.
- They ensure the pipe is centered during its passage through the casing to prevent friction.



DESCRIPTION

COMPOSITION:

- HDPE.

DIELECTRIC STRENGTH:

- >37kV /mm.

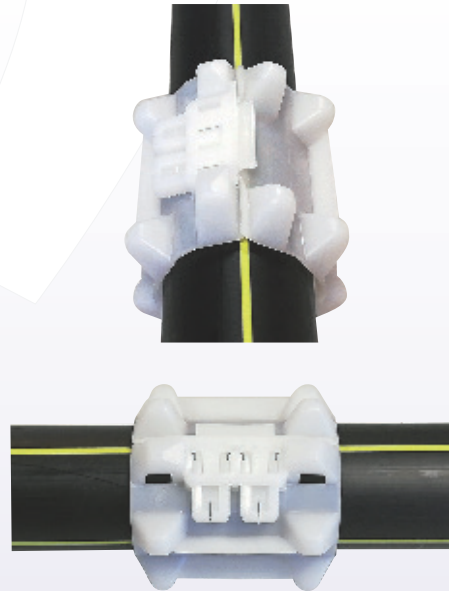

REFERENCES

CODE	DESIGNATION	NOMINAL DIAMETER	EXTERNAL DIAMETER	GRDF NOMENCLATURE
X262	SPACER FOR STEEL OR PE DN32 PIPE	32	42,4	86 02 053
X263	SPACER FOR STEEL OR PE DN50 PIPE	50	60,3	86 02 055
X264	SPACER FOR STEEL OR PE DN100 PIPE	100	114,3	86 02 060
X265	SPACER FOR STEEL OR PE DN150 PIPE	150	168,3	86 02 062
X266	SPACER FOR STEEL OR PE DN200 PIPE	200	219,1	86 02 065
X267	SPACER FOR STEEL DN250 PIPE	250	273	86 02 068
X268	SPACER FOR STEEL DN300 PIPE	300	323,9	86 02 070



EQUIPMENT FOR SECURING BRANCH VALVES

USAGE

- Different solutions are available for each case:
 - Flush valves: XA851 sealing cap.
 - Recessed valves: XA854 sealing cap with glue or XA856 sealing paste.
 - Tee-shutter valves: XA860 sealing pad.
 - Underground valves: XA835, XA836 and XA861 adjustable sealing cap.
 - Ball valves: XA865 and XA866 cable security seal.
 - Poline valves: XA852 rosette.

These solutions can be temporary and reversible or permanent. Please note that they are sold without clamps and without warning labels.



Round cap XA835



Round cap XA836

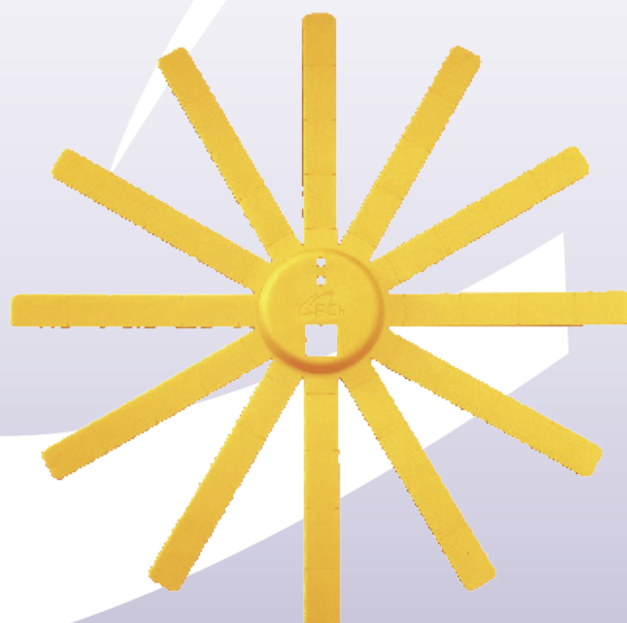

Round adjustable cap XA861



XA846



DESCRIPTION

COLOR:

- Yellow RAL 1023.

DIMENSIONS:

- XA835: external diameter 220 mm (8.66").
- XA836: external diameter 375 mm (14.76").
- XA852: external diameter 138 mm (5.43"), internal diameter 30 mm (1.18").
- XA854: diameter 44 mm (1.73").
- XA860: 220 x 220 mm (8.66" x 8.66").
- XA861: external diameter 400 mm (15.75").



XA851



XA854

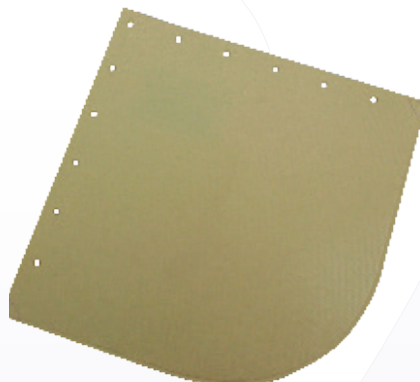

XA860



Back side view of the wall mount

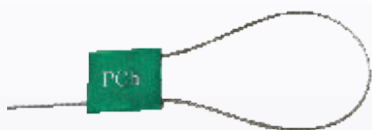

XA865

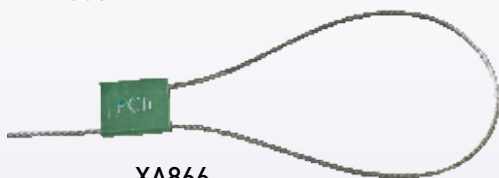

XA866



Rosette front side view

XA852

REFERENCES

CODE	DESIGNATION	GRDF REFERENCE
XA835	220 - 100 ADJUSTABLE SEALING CAP	86 15 002
XA836	375 - 250 ADJUSTABLE SEALING CAP	86 15 001
XA861	400 - 80 ADJUSTABLE SEALING CAP	86 15 003
XA851	LOCKOUT SIGN	86 15 021
XA854	ROUND LOCKOUT SIGN	86 15 023
XA855	WHITE MASTIC GLUE TUBE 70 ML	86 15 050
XA856	BI-COMPONENT SEALING PASTE	86 15 022
XA860	SEALING PAD	86 15 024
XA865	CABLE SEAL 1.0 MM	86 15 033
XA866	CABLE SEAL 2.5 MM	86 15 032
XA852	LOCKOUT ROSETTE	86 15 044





CORROSION PROTECTION

● PASSIVE PROTECTION

Petrolatum tapes.....	62
Rigid mold resin coating kit.....	64
Soft molds resin coating kit.....	66

● CATHODIC PROTECTION

Brazing pins.....	68
Aluminothermy kit.....	69
Gel connection boxes.....	70
Resin connection boxes.....	71
Measurement device.....	72
Anodes - Heat-shrinkable sleeves.....	73



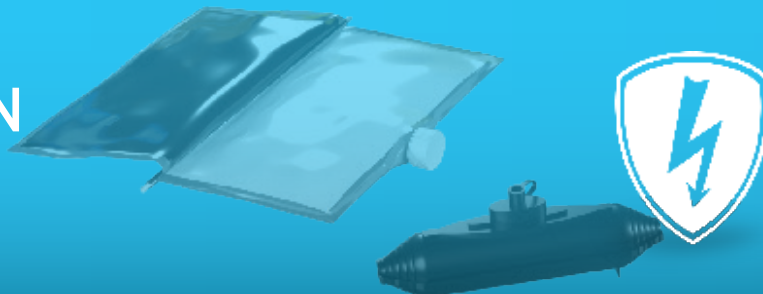

PETROLATUM TAPES

USAGE

- The Petrolatum DREVO 70 tapes are applied for corrosion protection with 50% overlap.
- The PVC DREVONYL tapes are applied as mechanical protection over the DREVO70 tapes with 50% overlap.
- DREVO mastic is used as additional protection before applying the DREVO tapes to smooth out angles on complex-shaped parts to be covered.

ADVANTAGES

- The manufacturing process of this tape ensures corrosion protection without the use of a primer.
- The flexibility of these tapes facilitates application without wrinkles or infiltration.
- DREVO 70 (2 layers) + DREVONYL (2 layers) products are certified to ISO 21809-3 standards.



Short version



Long version



NEW

DESCRIPTION

- DREVO70 tape: a synthetic non-woven backing impregnated throughout and coated on both sides with a petrolatum-based anticorrosive compound.
- DREVONYL protection tape: A mechanical protection tape made of a PVC film.



XD035



XD036



XD037

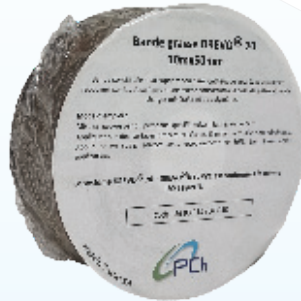

XD038



XD039

REFERENCES

CODE	DESIGNATION	GRDF REFERENCE
XD038	DREVO70 PETROLATUM TAPE 10 MX50 MM (32.8'X 2")	86 03 011
XD037	DREVO70 PETROLATUM TAPE 10 MX100 MM (32.8'X3.9")	86 03 012
XD036	DREVONYL PVC TAPE 20 MX50 MM (65.6'X2")	86 03 013
XD035	DREVONYL PVC TAPE 20X100 MM (65.6'X3.9")	86 03 014
XD039	DREVO MASTIC PASTE 10 KG (22LBS)	86 03 015

PASSIVE PROTECTION

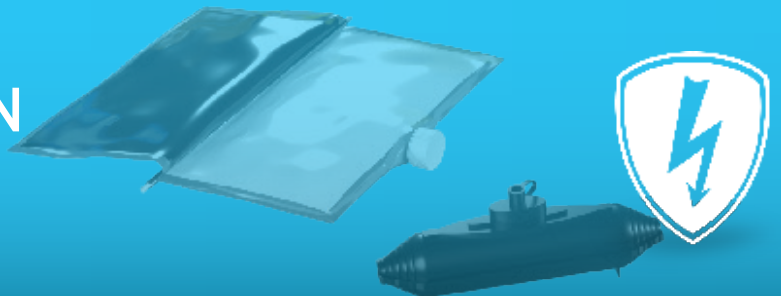

RIGID MOLD RESIN COATING KIT

USAGE

- Kit for corrosion protection of metal parts by bi-component resin coating

ADVANTAGES

- Guaranteed results and long-term reliability.
- Quick installation.
- GRDF-approved bi-component resin.
- Simplified waste management (elimination as “common industrial waste” after mixing the bi-pouch resin)
- Non CMR* resin.

* Carcinogenic, Mutagenic, or toxic for Reproduction.



DESCRIPTION

KIT COMPOSITION:

- Thermoplastic mold made of recycled material.
- Sealing tape.
- Screws and butterfly nuts.
- Bi-component resin (non-CMR substance).
- Nitrile gloves.
- Site protection tarpaulin.
- Transparent trash bag.

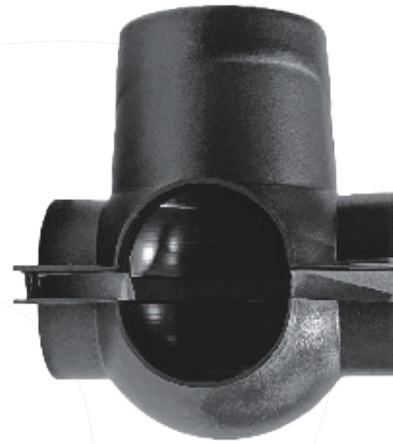

XD090

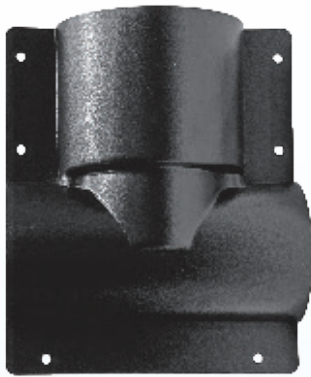

XD070
XD071
XD072

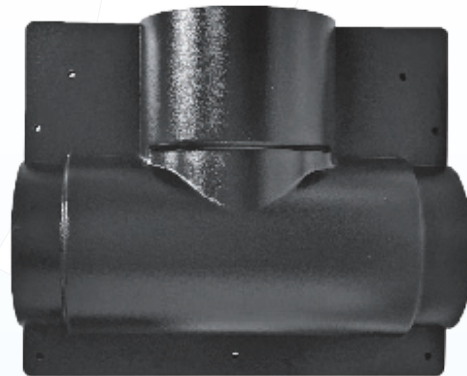

XD080 - XD081

REFERENCES

CODE	DESIGNATION	GRDF REFERENCE
XD070	COATING / LINSTOP FITTING P&TDW D.100	86 03 833
XD071	COATING / LINSTOP FITTING TDW D.150	86 03 829
XD072	COATING / LINSTOP FITTING TDW D.200	86 03 831
XD074	COATING / DECOMPRESSION TAPPING P&TDW D.150	86 03 903
XD080	COATING / CYLINDRICAL ENCAPSULATION LINSTOP FITTING D.150	86 03 969
XD081	COATING / CYLINDRICAL ENCAPSULATION LINSTOP FITTING D.200	86 03 976
XD090	COATING / SPHERICAL ENCAPSULATION LINSTOP FITTING D.100	86 03 978
XD050	0.45L BI-POUCH RESIN	86 03 905
XD053	1.75L BI-POUCH RESIN	86 03 907

Other references for Piedfort, Muller and TD Williamson are available on demand.

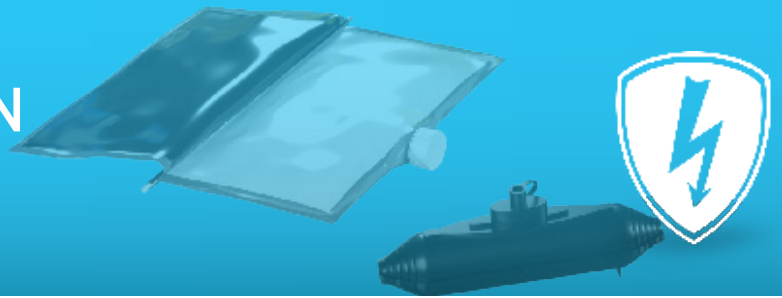

SOFT MOLDS RESIN COATING KIT

USAGE

These kits allow, depending on the application:

- To coat a steel or lead pipe when a connection is shutdown.
- To protect certain metal parts from corrosion (e.g. cast-iron heads or bezel clamps).

ADVANTAGES

- Minimum resin thickness guaranteed by a mechanical system integrated into the fabric casing.
- Bi-component resin (non-CMR substances) GRDF-approved.
- Maximum thickness limited by the application of specific bands.
- Integrated vents to facilitate degassing, visualize correct filling and, if necessary, allow filling at different points depending on the type of installation to be coated.
- Application using the bi-component resin pouch: contact-free application, carried out by a single operator.
- Simplified waste management (ordinary industrial waste elimination).



DESCRIPTION

KIT COMPOSITION:

- Waterproof fabric soft casing, with injection nozzle and vent.
- Compression band.
- Internal lining ensuring a minimum resin thickness.
- Heavy duty tie-wraps.
- Sealing tape.
- Non-CMR bi-component resin.
- Nitrile gloves.
- Site protection tarpaulin.
- Transparent garbage bag.

DECOMPRESSION TAPPING

XD075

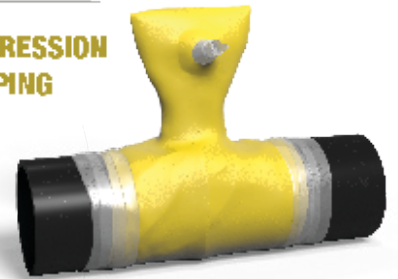

CAST-IRON HEADS OR BEZEL CLAMPS

XD061
XD062



CONNECTION SHUTDOWN direct

XD063

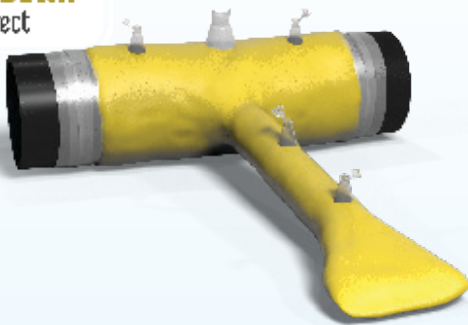

CONNECTION SHUTDOWN flange or C90

XD060
or
XD083

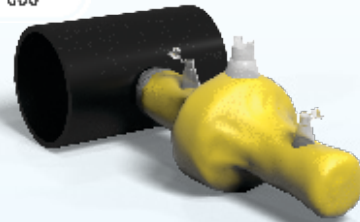

REFERENCES

CODE	DESIGNATION	GRDF REFERENCE
XD060	COVER FOR LEAD CONNECTION SHUTDOWN SIZE 25 TO 50	78 43 394
XD061	SHUTDOWN COVER DN 60 À 150	78 43 381
XD062	SHUTDOWN COVER DN 175 À 300	78 43 387
XD063	COVER FOR DIRECT CONNECTION SHUTDOWN	78 43 389
XD075	COVER FOR DECOMPRESSION TAPPING P&TDW D200 TO 300	86 03 923
XD083	COVER FOR CONNECTION SHUTDOWN C90	86 03 984
XD050	0.45L BI-POUCH RESIN	86 03 905
XD053	1.75L BI-POUCH RESIN	86 03 907

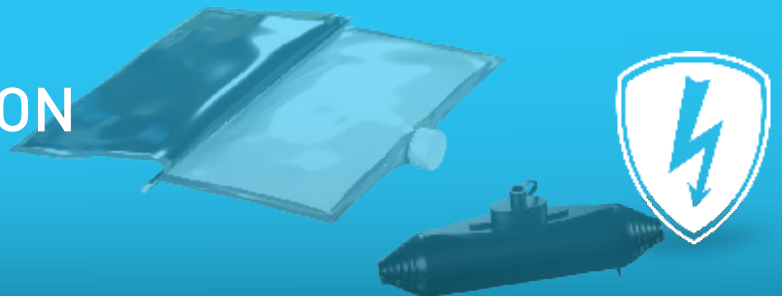

CATHODIC PROTECTION

GENERAL PRINCIPLE:

A metal pipeline must be protected against corrosion using two complementary methods:

- Its external coating that isolates it from the surrounding soil (referred to as passive protection).
- Its cathodic protection by lowering its electrical potential to limit the corrosion mechanism (typically less than a volt).

Brazing pins

USAGE

- Joining of a potential socket through “welding/brazing”.
- Protection of this socket by coating (epoxy resin).

ADVANTAGES

- Joining of a copper core cable ranging from 10 mm² to 5 mm².
- GRDF approved non-CMR epoxy resin.
- Bi-component pouch and injection nozzle that facilitates the application of the coating.
- Preserves the mechanical integrity of the pipelines.
- Simplified waste management (OIW) (Ordinary industrial waste).

DESCRIPTION

COMPLETE KIT INCLUDING

- Bi-component pouch and over-molding plastic housing.
- The brazing pins in steel (arc welding) or brass (soft brazing).
- Cable lugs, washers and bolts for cable connection.
- Tin for the brass kit.
- A metal handle and an anti-corrosion patch for the steel kit.

REFERENCES



XB125



XB126

CODE	DESIGNATION	GRDF REFERENCE
XB125	STEEL BRAZING PIN KIT	86 01 234
XB126	BRASS BRAZING PIN KIT	86 01 235

Aluminothermy kit

USAGE

- Connecting brazing pins to a metal pipeline using pyrometallurgical welding.
- Protecting the brazing pins by coating with epoxy resin.

ADVANTAGES

- No welding qualification required for implementation.
- GRDF approved non-CMR epoxy resin.
- Bi-component pouch and injection nozzle that facilitate the application of the coating.
- Preserves the mechanical integrity of the pipelines.
- Guaranteed results and long-term reliability.
- Simplified waste management (OIW) (Ordinary industrial waste).



DESCRIPTION

ALUMINOTHERMY KIT

- Brazing pins with pyrometallurgical welding system for connecting cables from 10 to 70 mm².
- Over-molding plastic housing.
- Bi-component pouch for anti-corrosion protection by coating.

ELECTRONIC IGNITER

- Electronic ignition box enabling remote ignition with a 1.8 m cord.

REFERENCES

CODE	DESIGNATION	GRDF REFERENCE
XB120	10-70 ALUMINOTHERMY BRAZING PIN KIT	86 01 222
XB121	REMOTE IGNITER CABLE 1.8 M	86 01 223
XD050 *	0.45L NON-CMR EPOXY RESIN BI-COMPONENT POUCH	86 03 905

* Additional packaging options available upon request.

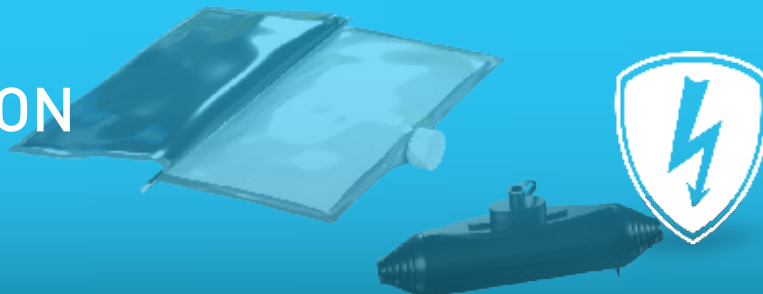

Gel connection boxes

- The gel box protects, insulates and seals in a single step.
- No expiration date for the gel.
- Clean implementation.



REFERENCES

CODE	DESIGNATION	GRDF REFERENCE
XB010	QUICKY GEL CONNECTION BOX 86*47*27	—
XB011	QUICKY GEL CONNECTION BOX (K1) 147*55*3	—
XB012	QUICKY GEL CONNECTION BOX (K2) 180*69*40	86 01 508
N707	BI-COMPONENT GEL BOTTLE OF 1L	—
N755	BI-COMPONENT GEL CARTRIDGE OF 265 ML	—

Resin connection boxes

USAGE

- Electrical cable connection, followed by encapsulation of the connection with epoxy resin.

ADVANTAGES

- GRDF and ENEDIS approved non-CMR epoxy resin.
- U.V. resistant casting box.
- Bi-component pouch and injection nozzle facilitating the implementation.
- Guaranteed results and long-term reliability.
- Simplified waste management (OIW) (Ordinary industrial waste).

DESCRIPTION

KIT COMPOSITION

- Thermoplastic mold.
- Sealing strip.
- Bi-component non-CMR resin.
- Nitrile gloves.
- Electrical connectors not included.



XD097

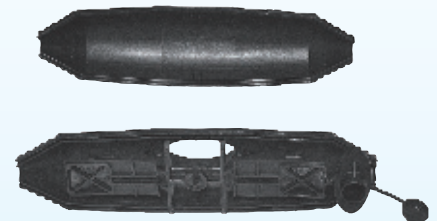

XD098

REFERENCES

CODE	DESIGNATION	GRDF REFERENCE
XD097	KIT OF TWO 200 ML CONNECTION BOXES	—
XD098	400 ML CONNECTION BOX KIT	—

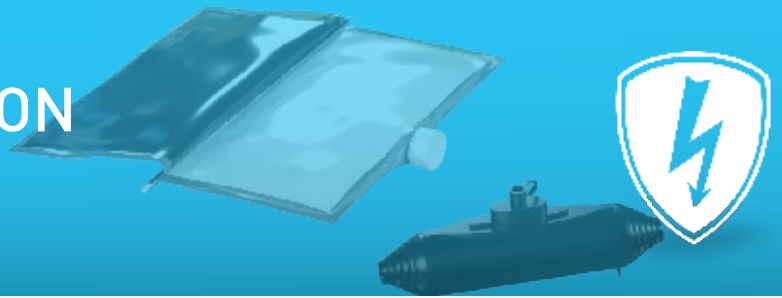

Measurement device

- The new MiniLog2 is a waterproof universal measuring instrument.
- Used in data logger mode, the MiniLog2 simultaneously records DC and AC voltage values for two channels.
- The MiniLog2 is capable of undertaking a combined CIPS and DCVG survey while recording the GPS position for each measurement point taken.



REFERENCES

CODE	DESIGNATION	GRDF REFERENCE
XB070	MEASUREMENT TERMINAL 2.5 TO 16 MM ²	86 01 703
XB071	2-WAY MEASUREMENT TERMINAL, FLEXIBLE CABLE	86 01 530
XB072	2-WAY MEASUREMENT TERMINAL, RIGID CABLE	—
XB073	MINILOG 2	86 01 605
XB074	LICENSE 2.0 WINLOG	86 01 630
XB075	2.0 WINLOG UPDATE 1 YEAR	—
XB076	GPS RECEIVER	—
XB082	1MA 100MV SHUNT	86 01 614
XB083	100MA 100MV SHUNT	86 01 616

Anodes

- Ferro-silicon anode for the cathodic protection of large or poorly insulated pipelines against corrosion by imposed current.
- 35kg Ferro-silicon (in compliance with BS 1591/75 grade Si 14).
- Material consumption : 0.5kg/year.



REFERENCES

CODE	DESIGNATION	GRDF REFERENCE
XB042	35KG FERRO-SILICON ANODE	86 01 304
XB043	20KG FERRO-SILICON ANODE	—

Additional products available upon request.

Heat-shrinkable sleeves

- Flexible polyolefin sleeve coated with thermofusible adhesive.
- Shrink capacity of 4/1.
- Operating temperature : - 45°C / + 105°C.
- 5 m roll.
- Recycled cardboard dispenser



REFERENCES

CODE	DESIGNATION	GRDF REFERENCE
XB001	16/4 HEAT-SHRINKABLE SLEEVE	—
XB002	24/6 HEAT-SHRINKABLE SLEEVE	—
XB003	32/8 HEAT-SHRINKABLE SLEEVE	—





TOOLS AND ACCESSORIES

● NETWORK PROTECTION

ATEX Tools.....	76
ATEX Signage.....	77
ATEX Lighting.....	78

● MECHANICAL PROTECTIONS

Bolt and gasket kits for flanges	80
Jointing paste for threaded metal assembly	82
Sealing products	83

● NETWORK ACCESSORIES

Temperature indicators.....	84
G4/G6 Meter accessories.....	86





ATEX TOOLS

USAGE

- This range of anti-spark tools allows for secure use on construction sites.

ADVANTAGES

- The copper-beryllium alloy used in the tools allows for the use of metallic tools in gas construction sites without emitting sparks.
- The handles are made of antistatic wood or plastic.

DESCRIPTION

MATERIAL:

- Copper-beryllium alloy.
- Antistatic handle.



REFERENCES

CODE	DESIGNATION	TOOL LENGTH	GRDF REFERENCE
XD125	NON SPARKING "CHISEL/BEDANE"	200 mm	77 36 46
XD126	NON SPARKING "PIN/BROCHE"	150 mm	77 36 49
XD127	NON SPARKING "CHISEL/BURIN" 200*22	200 mm	77 36 32
XD128	NON SPARKING "CHISEL/BURIN" 250*24	250 mm	77 36 34
XD129	STIFF PAINTER'S SCRAPER	200 mm	77 36 50
XD130	NON SPARKING HAMMER 340G	300 mm	77 36 03
XD131	NON SPARKING HAMMER 450G	325 mm	77 36 05
XD132	NON SPARKING SLEDGEHAMMER 3KG	700 mm	77 36 26
XD133	NON SPARKING MALLET 1KG	400 mm	77 36 16
XD134	NON SPARKING MALLET 500 G	310 mm	77 36 14
XD135	NON SPARKING TERRACING SHOVEL	990 mm	82 00 22
XD136	NON SPARKING TERRACING PICKAXE	910 mm	82 00 25



ATEX SIGNAGE

PVC CHAIN GAS ENCLOSURE:

- Yellow and black.
- Height of 900 mm, diameter of 50 mm, weight of 10 -15 KG (filled).
- Equipped with 2 rings for chain attachment.



XA870

CHAIN KIT + PANELS:

- Yellow and black.
- Length of 25 m (82'), diameter of 8 mm (0,31').
- 4 PVC panels of 250 mm x 150 mm (9.8''x5.9').
- 8 panel fixing hooks.



XA871

WARNING TAPE:

- ATEX black and yellow signage.
- Width of 75 mm, length of 100 m (328').
- Material: PE.



XA872

REFERENCES

CODE	DESIGNATION	GRDF REFERENCE
XA870	PVC ATEX ZONE GAS ENCLOSURE	37 02 008
XA871	25 M ATEX ZONE CHAIN + 4 PANELS	37 02 060
XA872	250 M*75 MM ATEX WARNING TAPE	96 96 001



ATEX LIGHTING

ADVANTAGES

- This range of lighting equipment ensures safe use in ATEX zone 0 construction sites.
- The large inspection lamp (XD138) has an articulated head.
- The zone lighting (XD137) comes with a magnetic base for 360-degree rotation and proper light placement. The lamp also features an adjustable steel handle for transportation. The product is delivered in a case with a 180 cm mast.

DESCRIPTION

CERTIFICATION:

- ATEX Zone 0.

AUTONOMY:

- XD 137: integrated rechargeable li-ion battery life of 6 hours (1200 lumens) to 12 hours (6500 lumens).
- XD 138: 3 AA 4.5v batteries included, with a life of 6 hours (329 lumens), 14 hours (185 lumens) to 15 hours (174 lumens).
- XD 139/ XD 141: included 3 AA 4.5v batteries, with a battery life of 19 hours (138 lumens).
- XD 140: included 3 AAA 4.5v batteries, with a battery life of 19 hours (30 lumens) to 47 hours (14 lumens).



XD140



XD138



XD139



XD141





XD137



XD137 valise



REFERENCES

CODE	DESIGNATION	GRDF REFERENCE
XD137	AUTONOMOUS ATEX ZONE 0 LIGHTNING	81 10 12
XD138	LARGE ATEX ZONE 0 INSPECTION TORCH	81 10 11
XD139	ATEX ZONE 0 FLASHLIGHT	81 00 16
XD140	ATEX ZONE 0 HEADLAMP	81 00 35
XD141	ATEX ZONE 0 TORCH FOR F1 HELMET	81 00 34
XD142	TWO F1 HELMET MOUNTS (G AND D)	81 00 36



BOLT AND GASKET KITS FOR FLANGES

USAGE

- These kits allow the replacement of the gasket and the entire set of bolts during an intervention on a flange.
- These sets are installed on gas networks and connections operated at a maximum pressure of 25 bar.

ADVANTAGES

- Complete kit for an intervention: bolts, nuts, washers, and gasket.
- Gasket protected from UV during storage and transportation.

DESCRIPTION

BOLTS:

- Class 8.8 bolts and washers, treated with zinc electrolyte coating.

GASKET:

- Synthetic fiber, elastomer compliant with standard NF-E29-533.





REFERENCES

CODE	DESIGNATION	GRDF REFERENCE
XD170	BOLTS AND GASKETS KIT FOR PN 25/40 DN 100 FLANGES, INCLUDING 8 BOLTS 8.8 M 20*80 AND 1 GASKET	22 00 113
XD171	BOLTS AND GASKETS KIT FOR PN 25/40 DN 150 FLANGES, INCLUDING 8 BOLTS 8.8 M 24*90 AND 1 GASKET	22 00 114
XD172	BOLTS AND GASKETS KIT FOR PN 25 DN 200 FLANGES, INCLUDING 12 BOLTS 8.8 M 24*100 AND 1 GASKET	22 00 115
XD173	BOLTS AND GASKETS KIT FOR PN 25 DN 300 FLANGES, INCLUDING 16 BOLTS 8.8 M 27*110 AND 1 GASKET	22 00 117
XD174	BOLTS AND GASKETS KIT FOR PN 10 BRASS VALVES DN 25 FLANGES, INCLUDING 4 BOLTS 6.8 M 12*50 AND 1 GASKET	22 00 210
XD175	BOLTS AND GASKETS KIT FOR PN 10 BRASS VALVES DN 32 FLANGES, INCLUDING 4 BOLTS 6.8 M 16*55 AND 1 GASKET	22 00 211
XD176	BOLTS AND GASKETS KIT FOR PN 10 BRASS VALVES DN 50 FLANGES, INCLUDING 4 BOLTS 6.8 M 16*55 AND 1 GASKET	22 00 212
XD177	BOLTS AND GASKETS KIT FOR PN 10 BRASS VALVES DN 50 FLANGES, INCLUDING 4 BOLTS 6.8 M 16*55 AND 1 GASKET	22 00 300
XD178	BOLTS AND GASKETS KIT FOR PN 10/40 DN 32 FLANGES, INCLUDING 4 BOLTS 8.8 M 16*70 AND 1 GASKET	22 00 301
XD179	BOLTS AND GASKETS KIT FOR PN 10/40 DN 40 FLANGES, INCLUDING 4 BOLTS 8.8 M 16*70 AND 1 GASKET	22 00 302
XD180	BOLTS AND GASKETS KIT FOR PN 10/40 DN 50 FLANGES, INCLUDING 4 BOLTS 8.8 M 16*70 AND 1 GASKET	22 00 321
XD181	BOLTS AND GASKETS KIT FOR PN 10/16 DN 65 FLANGES, INCLUDING 4 BOLTS 8.8 M 16*70 AND 1 GASKET	22 00 327
XD182	BOLTS AND GASKETS KIT FOR PN 10/40 DN 80 FLANGES, INCLUDING 8 BOLTS 8.8 M 16*70 AND 1 GASKET	22 00 322
XD183	BOLTS AND GASKETS KIT FOR PN 10/16 DN 100 FLANGES, INCLUDING 8 BOLTS 8.8 M 16*70 AND 1 GASKET	22 00 323
XD184	BOLTS AND GASKETS KIT FOR PN 10/16 DN 150 FLANGES, INCLUDING 8 BOLTS 8.8 M 20*80 AND 1 GASKET	22 00 324
XD185	BOLTS AND GASKETS KIT FOR PN 10 DN 200 FLANGES, INCLUDING 10 BOLTS 8.8 M 20*80 AND 1 GASKET	22 00 318
XD186	BOLTS AND GASKETS KIT FOR PN 10 DN 250 FLANGES, INCLUDING 12 BOLTS 8.8 M 20*80 AND 1 GASKET	22 00 319
XD187	BOLTS AND GASKETS KIT FOR PN 10 DN 300 FLANGES, INCLUDING 12 BOLTS 8.8 M 20*80 AND 1 GASKET	22 00 320
XD188	BOLTS AND GASKETS KIT FOR PN 16 DN 200 FLANGES, INCLUDING 12 BOLTS 8.8 M 20*80 AND 1 GASKET	22 00 326



JOINTING PASTE FOR THREADED METAL ASSEMBLY

USAGE

- This product allows sealing of threaded metal fittings.
- It polymerizes when confined in the absence of air between metal surfaces with a small clearance.
- This product should be stored close in a dry room between 8 and 21°C.

ADVANTAGE

- Prevents loosening and leaks due to shocks and vibrations.

DESCRIPTION

- Conforms to EN 751-1 class H standard and certified DVGW.



REFERENCE

CODE	DESIGNATION	GRDF REFERENCE
XD192	577 LOCTITE, 50 ML TUBE	82 79 088



SEALING PRODUCTS

USAGE

- This product allows the repair of leaking joints or micro cracks on above-ground low pressure installations.
- It is to be used on raised (building network) installations made of copper, lead, steel or stainless steel.

ADVANTAGE

- This product can be used on a gas-free or gas-containing installations.

DESCRIPTION

- Epoxy resin with metal powder and incorporated hardener.
- Temperature for use between 5 and 25°C.
- Delivered with nitrile gloves.



REFERENCE

CODE	DESIGNATION	GRDF REFERENCE
XD196	EPOXY STICK FOR COPPER OR STEEL	82 42 951



TEMPERATURE INDICATORS

USAGE

- Specially designed to provide accurate indication in preheat and post-weld heat treatment.

ADVANTAGES

- Precise and practical temperature indicator stick for measuring surface temperature.
- The stick melts instantly at the specified temperature for a simple and immediate visual check.
- Total reliability without calibration.
- Can be used on various types of surfaces:
 - Steel
 - Iron
 - Aluminum
 - Stainless
 - Steel
 - Glass
 - Plastic
 - Ceramic

DESCRIPTION

- Accuracy of +/-1% in Fahrenheit and +/- 3% in Celsius.
- Complies with preheat temperature requirements of: AWS D1.1, ASME Code Sec. I, III and VIII, ANSI/ASME.
- Code B31.1 and B31.3.
- Reference, temperature, and batch number are displayed on the indicator for better traceability.





REFERENCES

CODE	DESIGNATION	GRDF REFERENCE
XD200	KIT OF 20 INDICATORS	83 01 00
XD201	TEMPERATURE INDICATOR 50°	83 01 01
XD202	TEMPERATURE INDICATOR 110°	83 01 02
XD203	TEMPERATURE INDICATOR 115°	83 01 03
XD204	TEMPERATURE INDICATOR 130°	83 01 04
XD205	TEMPERATURE INDICATOR 132°	83 01 05
XD206	TEMPERATURE INDICATOR 155°	83 01 06
XD207	TEMPERATURE INDICATOR 165°	83 01 07
XD208	TEMPERATURE INDICATOR 180°	83 01 08
XD209	TEMPERATURE INDICATOR 184°	83 01 09
XD210	TEMPERATURE INDICATOR 239°	83 01 10



G4/G6 METER ACCESSORIES

USAGE

SEALING COLLARS:

- They block access to the assembly and disassembly of G4 or G6 meters to prevent fraud.
- They necessarily break during disassembly.

CLAMPING COLLARS:

- They allow positioning of remote radio modules on the front face of G4 meters.

METER CAPS:

- They are installed either:
 - At the end of the assembly line before shipping, these caps prevent any foreign bodies from entering the meter before installation.
 - Upon removal of the used meter, these caps prevent residual gas (lighter than air) from diffusing into a vehicle and/or a room.

ADVANTAGES

- Quick installation without tools (for all of its solutions).



XE901



XE900



DESCRIPTION

SEALING COLLARS:

- Bears the inscription «Breaking this seal will result in prosecution - GRDF.
- Height of 17 mm to protect the nut screwed onto the DN20 input pipe of a G4 caliber meter.
- Height of 21 mm to protect the nut screwed onto the DN32 input pipe of a G6 caliber meter.
- Color: translucent.

CLAMPING COLLARS:

- Length: 750 mm.
- Width: 7,5 mm.

METER CAPS:

- DN20 for G4 meters.
- DN32 for G6 meters.

REFERENCES

CODE	DESIGNATION	GRDF REFERENCE
XE900	SEALING COLLAR FOR G4 METER DN20	41 21 200
XE901	SEALING COLLAR FOR G6 METER DN32	41 21 201
XE902	SET OF 50 CLAMPING COLLARS 750 MM	41 23 023
XE903	METER CAP FOR G4 DN20	41 21 202
XE904	METER CAP FOR G6 DN32	41 21 203

GRDF CLÉ DE FERMETURE GAZ

A REMPLIR EN CAS DE DANGER, FUITE DE GAZ OU INCENDIE

- 1°) Prendre la clé de manœuvre du robinet et d'ouverture du regard.
- 2°) Relever le regard vers le robinet à fermer (général ou local) par la zone de responsabilité "GRDF" (personnel qualifié).
- 3°) Couper le regard.
- 4°) Déposer éventuellement la clé du robinet.
- 5°) Introduire la clé sur la tête du robinet.
- 6°) Tourner le robinet en tournant strictement dans le sens des aiguilles d'une montre (à l'arrêt).
- 7°) Vérifier au niveau de la tête du robinet.
- 8°) Présenter au futur client la "garantie GRDF".

PRODIGES : 18 000 000 000

URGENT : UN HOMME VIVANT SOUS LE VESTIBULE MALHEUREUX PEUT ÊTRE TUÉ PAR UN ACCIDENT DE GAZ.

CONSIGNES GÉNÉRALES EN CAS DE FUITE DE GAZ

- Crier, sans faire de bruit.
- Ne pas marcher, d'interdire l'accès de toutes personnes, de fermer les portes, de couper l'électricité (sauf dans les cas exceptionnels).
- Ne pas fumer.
- Vérifier les brûlures.
- Ne pas chercher à faire entrer quelqu'un dans la zone accidentée.

PCN 18







SIGNAGE

Signage.....	90
Signage cases.....	91

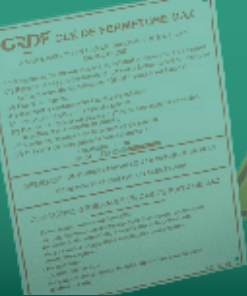



SIGNAGE CASES

	GRDF REFERENCE PCH CODE	DESIGNATION
	86 42 127 XA801	LARGE CASE OF NUMBERS AND LETTERS FOR T200B PLATES.
	86 42 132 XA802	SMALL CASE OF NUMBERS FOR T200B PLATES.



PCh

Expertise adapted to your needs

**CHEMIN DE CRAPIER - ZI - CS 40092
SAINT-SORLIN-EN-BUGEY - 01154
LAGNIEU
FRANCE**

**HEADQUARTERS: +33 4 74 38 77 65
SALES: +33 4 74 38 05 94
EMAIL: adv.export@pch-sas.com**

www.pch-sas.com

Non-contractual images and texts